

Rostock MAX v2 User's Guide



SeeMeCNC™
3D Printers & More

Welcome to the User's Guide for the Rostock MAX v2.0 3D printer.
Version 1.52, September 28th, 2016

First Edition

Covers MatterControl v1.4

Copyright 2015 by Gene Buckle

Licensed as Creative Commons Attribution-ShareAlike 3.0

Questions or corrections should be emailed to geneb@deltasoft.com



Read Me First!

This document is your instruction manual for your new SeeMeCNC® 3D printer machine. Before using your new 3D printer, thoroughly read and understand this manual for safe and effective operation of the machine.





Warning	
Personal property damage, serious injury or death can result from not following instructions or warning in the manual or misuse of the machine.	
Automatic machine can start unexpectedly. Pay close attention and keep clear while power is connected to the machine	
Adult supervision required. Children under 18 years of age require supervision.	
 <div style="border: 1px solid black; padding: 5px;"> <p>⚠ DANGER</p> <p>Shock Hazard. Disconnect power before servicing. Improper use will result in serious injury or death.</p> </div>	The machine power supply is connected to AC voltage and can be hazardous. Disconnect power before servicing this machine.
 <div style="border: 1px solid black; padding: 5px;"> <p>⚠ CAUTION:</p> <p>Hot Surface. Do NOT touch. Allow to cool before servicing.</p> </div>	The hot end of the machine can reach very high temperatures of 700F and can cause serious burns. The heated print surfaces (heated bed) can also reach temperatures high enough to cause severe burns. Allow both to cool for 20 minutes after turning off power.
 <div style="border: 1px solid black; padding: 5px;"> <p>⚠ CAUTION:</p> <p>Pinch Point. Keep hands and fingers clear.</p> </div>	Use caution near moving parts of the machine. Keep body and loose articles clear.
	Risk of Fire. Do not leave machine unattended.
Use genuine parts manufactured or designated by SeeMeCNC.	
Poisonous gas, smoke, or fumes could be emitted by some materials you could use with the machine. In such case, you should install ventilation.	
	Choking Hazard. This machine contains small parts and can produce small parts which can be a choking hazard to children.
Keep a copy of this manual near the machine, easily accessible to all operators.	
Use of this machine is at your own risk.	
Visit http://www.seemecnc.com to contact us if you have any questions.	

Table of Contents

READ ME FIRST!.....	2
0 – Introduction and Acknowledgments.....	4
1 – Driver and Software Installation.....	5
1.1 – Installing the RAMBo Driver.....	5
1.2 – Installing the Arduino IDE.....	7
1.3 – Configuring the Arduino IDE.....	8
1.4 – Test Upload.....	9
1.5 – Uploading Repetier-Firmware.....	11
1.6 – The LCD and Front Panel Controls.....	13
2 – Installing MatterControl and Calibrating the Printer.....	16
2.1 – Downloading, Installing, and Configuring MatterControl.....	16
2.2 – Initial Function Tests.....	22
2.3 – Setting the Z Height.....	27
2.4 – Motion Calibration.....	29
2.5 – Verifying Extruder Stepper Operation.....	32
2.6 – Extruder Calibration.....	32
3 – First Print: PEEK Fan Shroud.....	34
3.1 – Configuring the Slicer.....	34
3.2 – Printing The PEEK Fan Shroud.....	36
3.3 – Loading Filament.....	37
3.4 – Preparing the Heated Bed.....	38
3.5 – Printing the PEEK Fan Shroud.....	39
3.6 – Installing the PEEK Fan and Shroud.....	41
4 – Second Print: Layer Fan Shroud.....	44
5 – Matter Control Basics: Slicing.....	47
6 – MatterControl Basics: Loading and Printing Objects.....	61
7 – Advanced MatterControl: Configuration.....	67
8 – Advanced MatterControl: Settings – General.....	71
9 – Advanced MatterControl: Settings – Filament.....	81
10 – Advanced MatterControl: Settings – Printer.....	85
11 – Using the 3D and Layer Views.....	88
12 – A Strategy for Successful (and great!) Prints.....	97
Appendix A: Maintenance and Troubleshooting.....	110
Print Layer Issues.....	111
Machine Won't Move!.....	113
LCD Panel Not Working.....	113
Appendix B: Alternate Calibration Method.....	115
Appendix C: The MatterControl Touch.....	119
Appendix D: Printing From the SD Card.....	126
Appendix E: Optimizing The Temperature Control Algorithms.....	127

0 – Introduction and Acknowledgments

I'd like to welcome you to the 1st Edition of the Rostock MAX v2 User's Guide!

Acknowledgments

I'd like to thank the gentleman that runs <http://minow.blogspot.com.au/> for his excellent guide on calibrating delta configuration 3D printers.

I'd also like to thank the whole gang over at the SeeMeCNC forums for providing excellent feedback. This would be a much lesser creation without their contributions and insights.

1 – Driver and Software Installation

The Rostock MAX v2 does not include the firmware required to operate it. This was a conscious decision by SeeMeCNC to encourage builders to become more proficient in the operation of their new 3D printer.

Downloading the tools necessary to build and upload Repetier-Firmware is simple and easy. However, before you get to that point, you're going to need to install a driver in order to communicate with the RAMBo controller. If you're using MacOS or Linux, you can skip the driver installation instructions.

1.1 – Installing the RAMBo Driver

Download the USB Driver zip file from this location:

http://download.seemecnc.com/Software/RAMBo_USBdriver.zip

The driver will work with all versions of Windows – XP to v8.1.

If you haven't done so already, connect the Rostock MAX to your computer using the included USB cable and turn the Rostock MAX on using the power switch you installed previously.

Unzip the file to a temp directory or other place that you know the location of. For Windows users (and likely XP, Windows 8 and Vista users as well), plug in the RAMBo and let Windows “fail” to find the correct driver for the board. Open up the device manager by right-clicking on “Computer” or “My Computer” and select “Properties” followed by “Device Manager”. Scroll down to the “Unknown Devices” entry and right-click on the RAMBo entry. Choose “Update Driver” and then “Browse my computer for driver software” (or something similar to this). Choose “Let me pick from a list of device drivers on my computer”, then click the button for “Have Disk”. Browse to where you unzipped the file you downloaded and then click “OK”. It may complain (depending on OS) that the driver isn't signed – allow it to install it anyway. That's all there is to it. The RAMBo will now appear on your computer as a standard serial port. On my computer it appeared as COM10 – it will most likely be different on yours.

Rostock MAX v2 User's Guide

The easiest way to find out what port your RAMBo is listening on is to open up the Device Manager and look for the RAMBo entry. In order to discover this bit of information, you'll need to open up Device Manager (right click on My Computer, click “Properties” and then click “Device Manager”). You'll get a window that looks something like this:

The entry we're looking for is highlighted in green. Your “COM” entry will more than likely be different from mine. Write this entry down as you'll need it very soon.

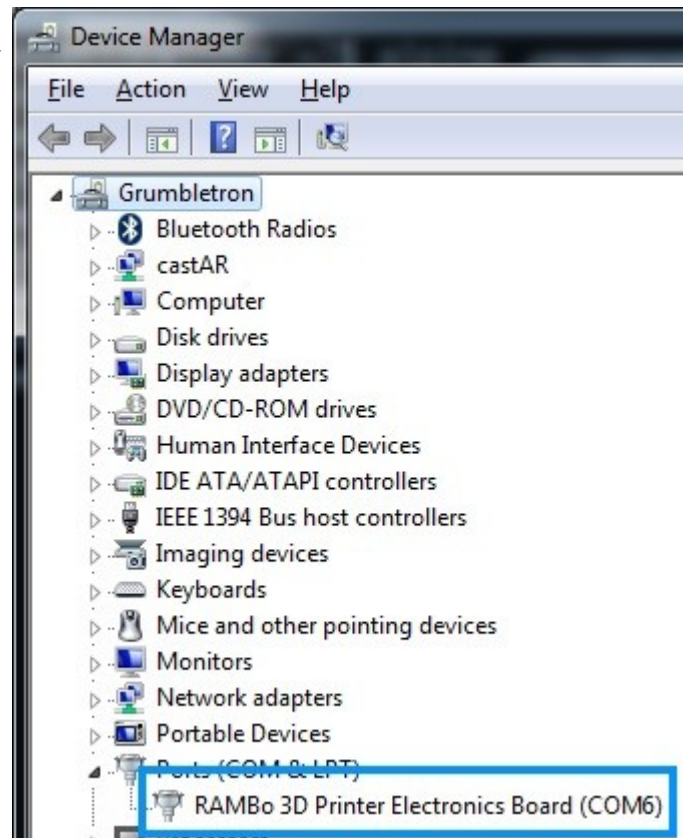

Fig. 1.1-1: The RAMBo in the Device Manager

1.2 – Installing the Arduino IDE

In order to compile and upload the firmware to the RAMBo controller, you're going to need the Arduino IDE. This is an open source software development environment targeted at the Arduino family of ATmega-based microcontroller project boards. At its heart, the RAMBo controller is just an Arduino Mega 2560 with a *lot* of goodies attached to it.

You can download the Windows, MacOS and Linux version of the Arduino IDE from here:

<http://arduino.cc/download>

The version of the IDE used as of this writing is 1.6.1, but later versions can be used.

Install the Arduino IDE using the downloaded installer.

Now you need to download the firmware from SeeMeCNC's github repository.

<https://github.com/seemecnc/Firmware/archive/master.zip>

Unpack the “master.zip” file that you downloaded into a directory where you can keep track of it. You may need to reference it in the future.

Start the Arduino IDE – you should be presented with a screen that looks similar to this:

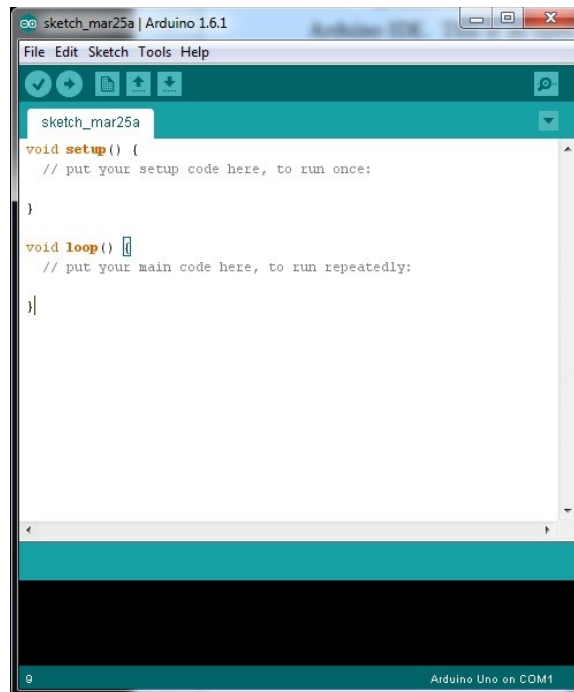

Fig. 1.2-1: The Arduino IDE

1.3 – Configuring the Arduino IDE

Before we can use the IDE to upload the firmware to the RAMBo controller, we need to tell the Arduino IDE what kind of board we have and what communications port it needs to use in order to perform the upload task.

Click on the “Tools” menu item and then click on “Board” and then “Arduino Mega or Mega 2560”.

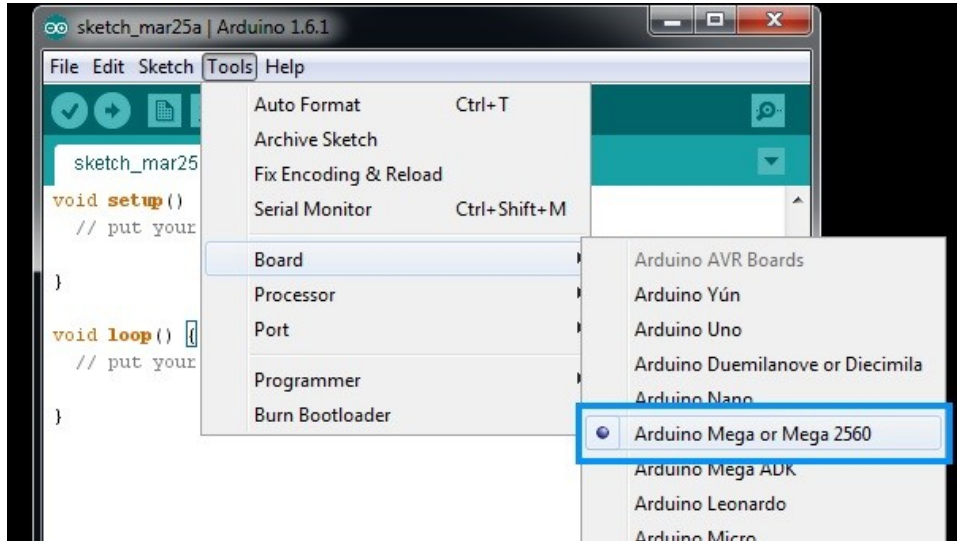

Fig. 1.3-1: Choosing the board type.

Next, you'll need to tell the Arduino IDE what port to talk to the RAMBo on. To do this, click on “Tools”, “Serial Port” and then choose the COM port that your RAMBo appears as on your computer.

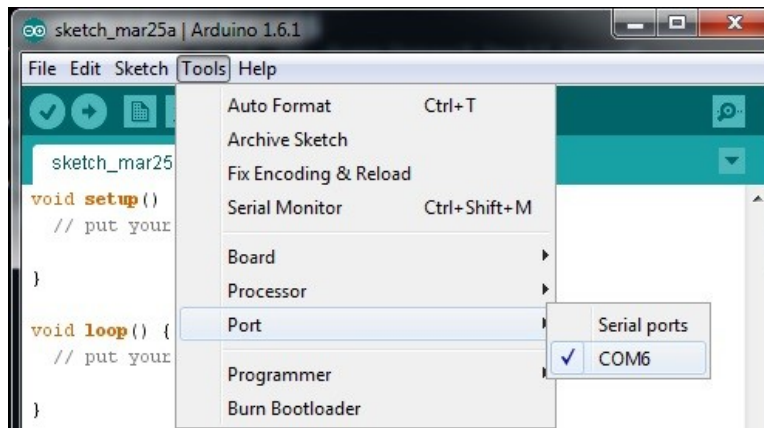

Fig. 1.3-2: Choosing the Serial Port.

1.4 – Test Upload

Ok, now that you've got the Arduino IDE configured, we're going to do a quick task that'll do two things. First, it will validate that you've got the Arduino IDE configured properly and that you're able to connect and upload a program to the RAMBo controller. Remember – the RAMBo controller is just an Arduino Mega 2560 with a bunch of goodies piled on top!

Second, the program I'm going to have you run will clear the EEPROM on the RAMBo controller to make sure you start with a clean slate. The EEPROM is an Electrically Erasable Programmable Read Only Memory and it's where Repetier-Firmware will store settings. When you can store configuration information in the EEPROM, it means that you don't have to re-upload the firmware every time you make a change.

Click on “File”, “Examples”, “EEPROM”, and finally “eeprom_clear” as highlighted in blue in the figure below.

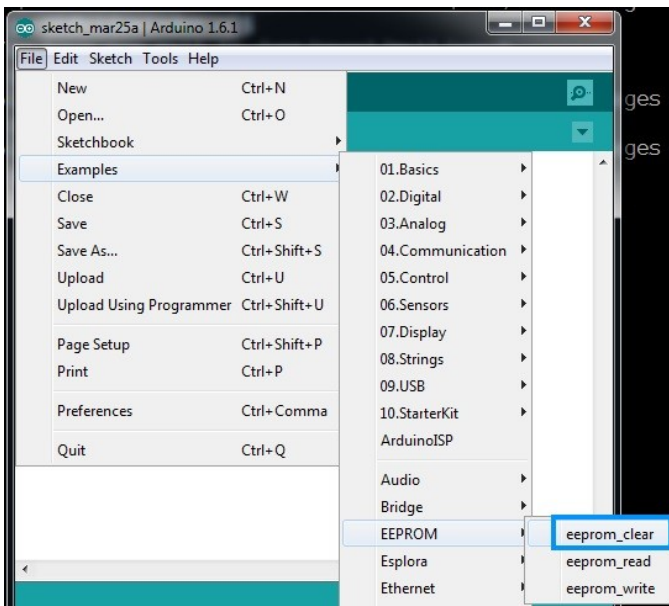

Fig. 1.4-1: Loading the eeprom_clear program.

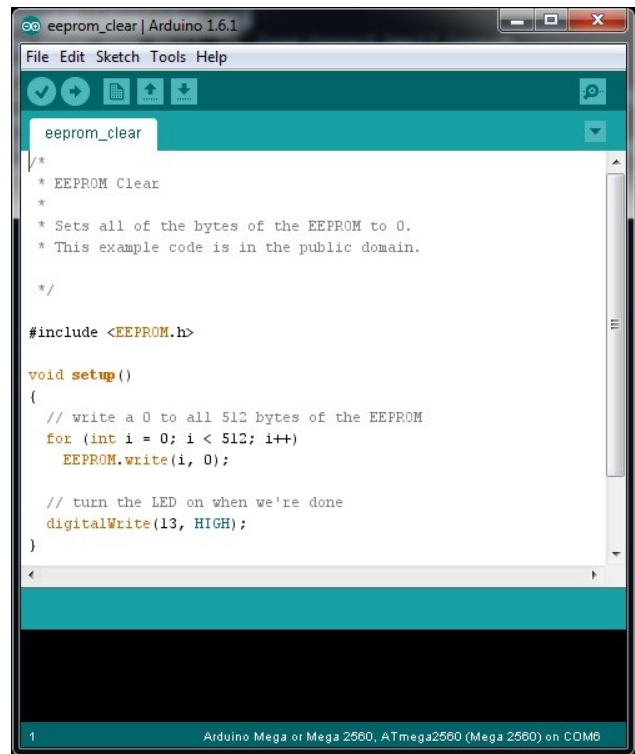

Fig. 1.4-2: eeprom_clear loaded & ready to go.

The only thing you need to do now is click the “Upload” icon in the Arduino IDE. The upload icon is represented by this symbol:



Rostock MAX v2 User's Guide

Turn your Rostock MAX v2 on if you haven't already and then click the Upload icon.

When the upload is finished, you should see results similar to that on the right. The “Done uploading” is the status you want. There is no other external evidence that the eeprom_clear program has done its job, but it has!

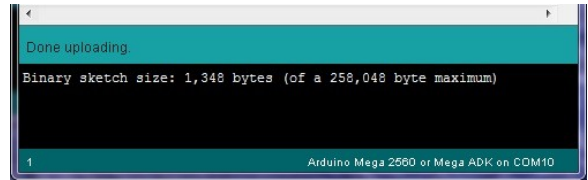

Fig. 1.4-3: Success!

1.5 – Uploading Repetier-Firmware

Now it's time to load Repetier-Firmware into the Arduino IDE and upload it to the RAMBo controller! Click “File”, “Open” and browse to where you unpacked the master.zip file you downloaded from the SeeMeCNC github repository. Select the file “Repetier.ino” and click the Open button. Note that Windows may hide the program suffix (.ino) from you.

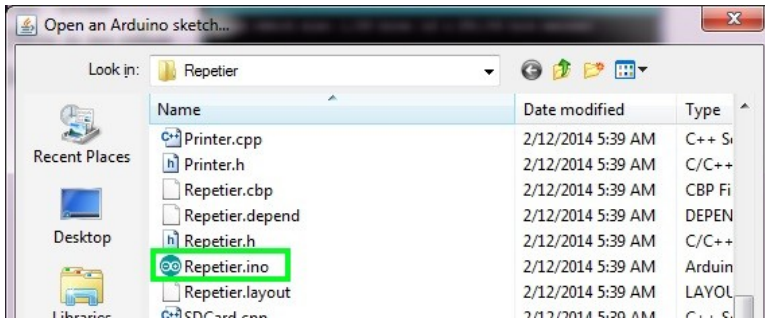

Fig. 1.5-1: Opening Repetier.ino

Before you can upload the firmware to the RAMBo, you're going to need to make two small changes to how the firmware is configured. Once you have the firmware loaded in the Arduino IDE, click on the tab marked **Configuration.h**.

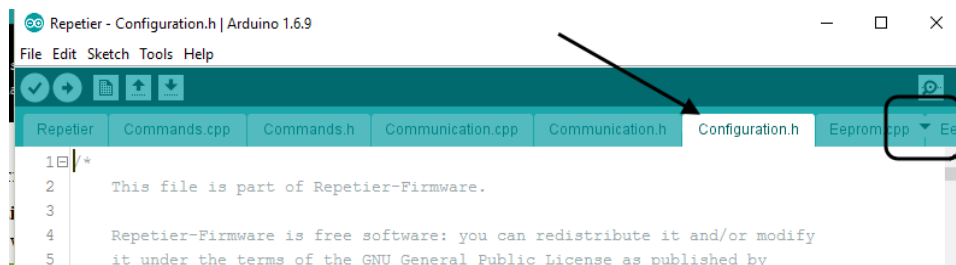

Fig. 1.5-2: The Configuration.h tab in the editor.

Now scroll down a short way until you see the section that matches the figure below.

You'll need to make sure that the **MOTHERBOARD** definition is set to “301” for the RAMBo board and the **PRINTER** option is set to “2” for the Rostock MAX v2. Click on the **Save** icon to save your changes.

```

41 // 301 = RAMBO    302 = MINI_RAMBO
42 #define MOTHERBOARD 301
43
44 /* Define Priner being used
45   Orion = 1
46   Rostock Max V2 = 2
47   ERIS = 3
48   DROPLIT = 4
49 */
50 #define PRINTER 2
    
```

Fig. 1.5-3: Configuration options.

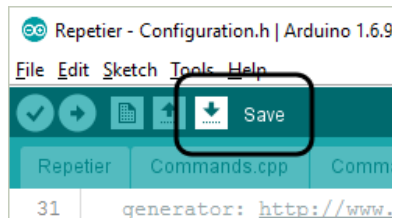

Fig. 1.5-4: Save changes!

Now you can click on the **Upload** icon to send the firmware to the RAMBo!

Depending on the speed of your computer, this could take up to a few minutes to accomplish. Be patient and wait for the “Done uploading.” status to appear just like it did when you uploaded the “eeprom_clear” program.

You may see a warning similar to the one shown below. This is strictly an advisory message and won't affect how the firmware works with your Rostock MAX.

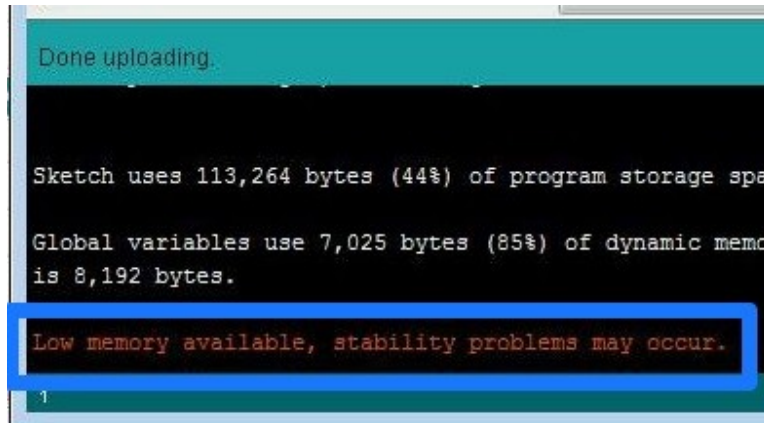

Fig. 1.5-5: Compiler advisory message.

When the upload has finished the RAMBo will restart and you should see the following display on the LCD:



Fig. 1.5-5: It's **ALIVE!**

Congrats again! You've got a living, breathing (hey, work with me here!) 3D printer that you've *built yourself*. If for some weird, inexplicable reason you do NOT see that display (or something very, very similar!), carefully retrace your steps. Start back at the beginning with the eeprom_clear test and go from there. If you still don't get a working display please check Appendix A, or contact support@seemecnc.com!

1.6 – The LCD and Front Panel Controls

Let's go over what information the LCD displays and what the front panel controls do.



Fig. 1.6-1: Default LCD display.

1. Nozzle Temperature. This is the temperature at the nozzle as measured by the thermistor that you installed when you put the hot end together. It reads in degrees Celsius – you'll find quickly that just about everything to do with 3D printing is done in Metric units of measure. FYI, 18.4C is 65.12F.
2. Target Nozzle Temperature. When you're printing a part, this field will show you what temperature you've set the hot end to.
3. Bed Temperature. This is the temperature of the Onyx heated bed as measured by the thermistor that you installed in the center of the bed. Just like the nozzle, it reads in Celsius.
4. Target Bed Temperature. This displays the temperature that you've set the Onyx to heat to.
5. Speed Rate. This is the speed multiplier field. Normally it will read 100%, but if you've changed the speed control from MatterControl, this number will display what that setting is. We'll get into this in more detail later.
6. Flow Rate. This shows the current flow rate of the extruder. This is also a field that is controlled from MatterControl.
7. Status Line. This is a multipurpose display field that will change depending on what the printer is currently doing.

The front panel:



Fig. 1.6-2: The Front Panel.

1. The LCD Display. (but you knew that, right?)
2. Beeper. That's it does. Beeps. (and beeps, and beeps and beeps...)
3. Input Controller. Turning the knob clockwise & counter clockwise is how you navigate through the LCD menus. Pressing the button straight in acts similarly to a mouse click – it selects the current menu item.
4. Emergency Reset Button. When you hit that button, a number of things are going to happen. First, the RAMBo is going to turn off both the heat bed and the nozzle heaters. Next, it's going to send all three Cheapskates to their “home” positions at the top of the Rostock MAX v2 and then the RAMBo controller will reboot itself. If the printer is really going nuts on you, this is the second fastest way to make it behave. (The first is to turn the power off!)

Note that in order to operate the reset button, you need to press **hard**. You'll hear it click, but that's kind of deceptive. The button doesn't close until more force is applied to the little reset button arm. It is somewhat of a safety feature to prevent accidental resets during a print job.

Rostock MAX v2 User's Guide

The last thing I'm going to cover in this section is the “activity” display that the LCD can show you. Turn the knob either direction and you'll get a display that looks something like this:

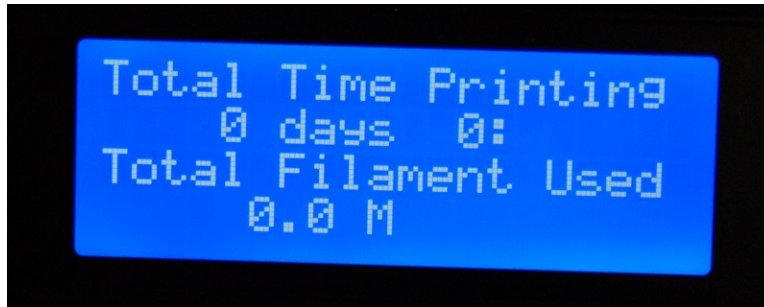

Fig. 1.6-3: Activity display.

This will tell you at a glance how much time your Rostock MAX v2 has spent printing and how much filament it's used in the process. The time display breaks down into days, hours and minutes. The filament display shows filament used in fractional meters.

Now let's get this thing calibrated and printing!

2 – Installing MatterControl and Calibrating the Printer

This is the fun part! The Rostock MAX v2 3D printer is very easy to calibrate, but it can take some time and a number of iterations to get it as good as you can. You'll want to take your time here because the better you calibrate the printer, the better it will perform.

2.1 – Downloading, Installing, and Configuring MatterControl

The “host” software of choice for the Rostock MAX is called MatterControl.

MatterControl is a full featured and multi-platform host interface for 3D printers. There are other host interfaces out there such as Octoprint, Repeater-Host, and Pronterface, but this guide will only cover MatterControl. MatterControl is available for Windows and MacOS platforms. If you've got a Linux machine, you'll want to look into either Pronterface or Repetier-Host.

MatterControl can be downloaded from <http://seemecnc.com/pages/downloads>. Scroll down to the “Software” section.

After the download completes, run MatterControl and click on “Add Printer” button as shown below. This will open a dialog box that you'll use to select your printer model and give it a name.



Click in the “Printer Name” field and enter a name for your Rostock MAX v2 3D printer. I've named mine “Walter”. (Yes it's weird. I'm weird. Deal with it.)

Select “RostockMAX” from the “Select Model” drop-down.

Note that since you're using the SeeMeCNC customized version of MatterControl, the model drop-down will only contain the models of SeeMeCNC made printers as well as “Other” if you'd like to configure MatterControl to use a non-SeeMeCNC printer in the future.

Click the “Save & Continue” button to continue.

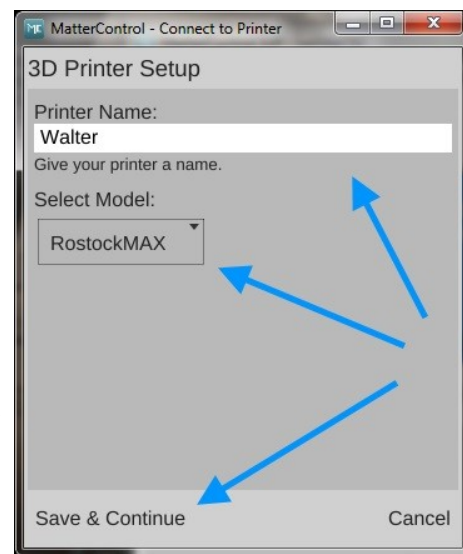

Fig. 2.1-1: Printer setup.

When you save the new profile, you'll be prompted to install a driver. Since you've already installed the RAMBo driver to load the firmware on your new Rostock MAX v2, you can safely click “Skip”.

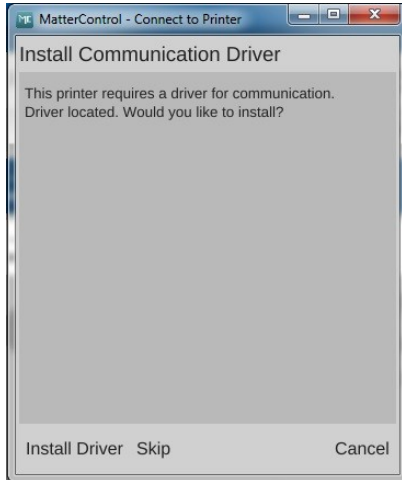

Fig 2.1.-2: Driver dialog.

MatterControl can detect what kind of firmware it's talking to based up on the response it gets for this step.

The dialog shown on the right is a bit unclear – the MatterControl guys are assuming that you might have gotten ahead of yourself. If you DID connect MatterControl (using the CONNECT button), go ahead and click the DISCONNECT button and then bring the 3D Printer Setup dialog to the front by clicking on it in the task bar.

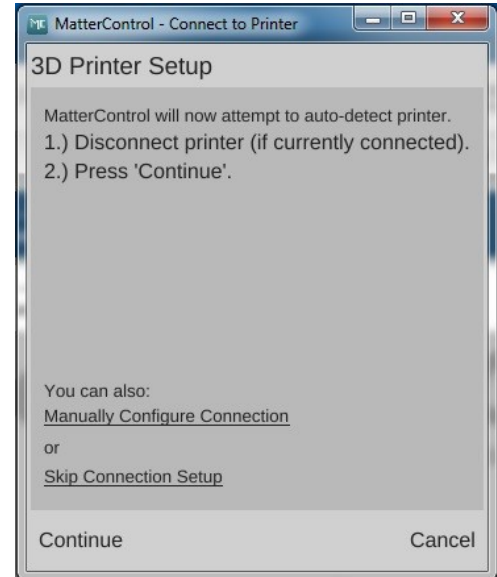

Fig. 2.1-3: Connecting to the printer.

Go ahead and click the Continue button. You'll be presented with a new dialog as shown below on the left.

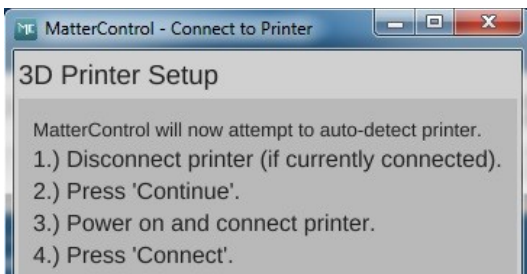

Fig. 2.1-4: 3D Printer Setup.

Make sure you've got the USB cable connected to the RAMBo and your computer. Power on your Rostock MAX v2 and then click the “Connect” button.

If for some reason MatterControl cannot “see” the Rostock MAX v2, you may see an error like the one shown on the right.

If you do get this error, click on the “Manual Configuration” link at the bottom of the dialog box.



Fig. 2.1-5: Oops!



Fig. 2.1-6: Manual Configuration

The Manual Configuration link will bring up a dialog box that allows you to choose which communication port your printer is connected to.

You'll be presented with a list of the serial ports that MatterControl can currently “see”. If you don't see any ports, or the one you need isn't listed, then click the “Refresh” button at the bottom of the dialog. If the port STILL does not appear, check to make sure that the USB cable to the Rostock MAX v2 is correctly connected and the printer is turned on. If you still see no port after clicking Refresh, please contact SeeMeCNC support!

If your port is listed, click on the little circle to select it and then click the “Connect” button at the bottom of the dialog. You should be rewarded with the following dialog:

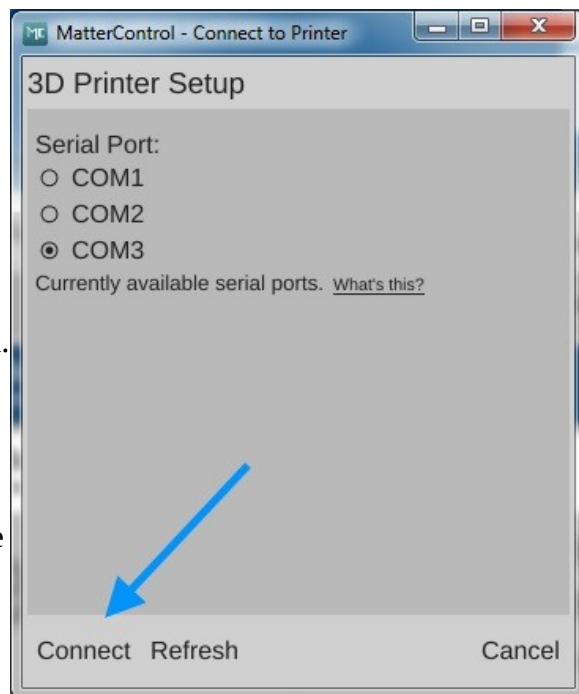

Fig. 2.1-7: Serial port selection

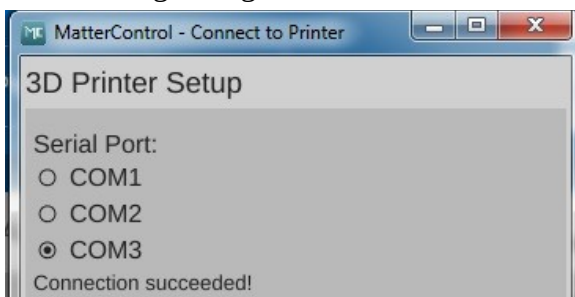

Fig. 2.1-8: Success!

Rostock MAX v2 User's Guide

Click the “Done” button and let's continue!

Maximize the MatterControl window to see the entire main screen. If you shrink the size of the main window, features “fold” away to keep from cluttering the display. It's actually pretty clever.

Before we get to the details of getting your printer calibrated, let's cover what features are available from MatterControl. Because the MatterControl display does contain so much information, I'm going to break it down into smaller segments to make the screen shots easier to see as I describe the various components in MatterControl.

1. This is the print queue display. If nothing is queued up, you'll see the message, “No items in the print queue”. To add an item, click the “Add” button (#13). We'll cover this in detail later. Note that you can only select STL or GCODE files.
2. This is the temperature display. The top number displays the current nozzle temperature and the bottom number covers the heated bed. Both temperatures are displayed in degrees Celsius.
3. Queue count. This lists the number of objects currently loaded in the print queue.
4. Library – this is a list of items that you've stored in your object “library”. We'll cover this one in detail later as well.
5. Print History – Clicking here will show you information about your recent print jobs, including their start & end times as well as whether or not the job was completed.
6. Settings & Controls – this is where you can edit your slicer & printer settings as well as manually control your Rostock MAX v2.
7. The **Edit** button will allow you to choose which items in the print queue will be available for printing.
8. The **Export** button will allow you to export the currently select item as an STL, AMF, or GCODE file. You can use this to save GCODE to an SD card for stand-alone printing

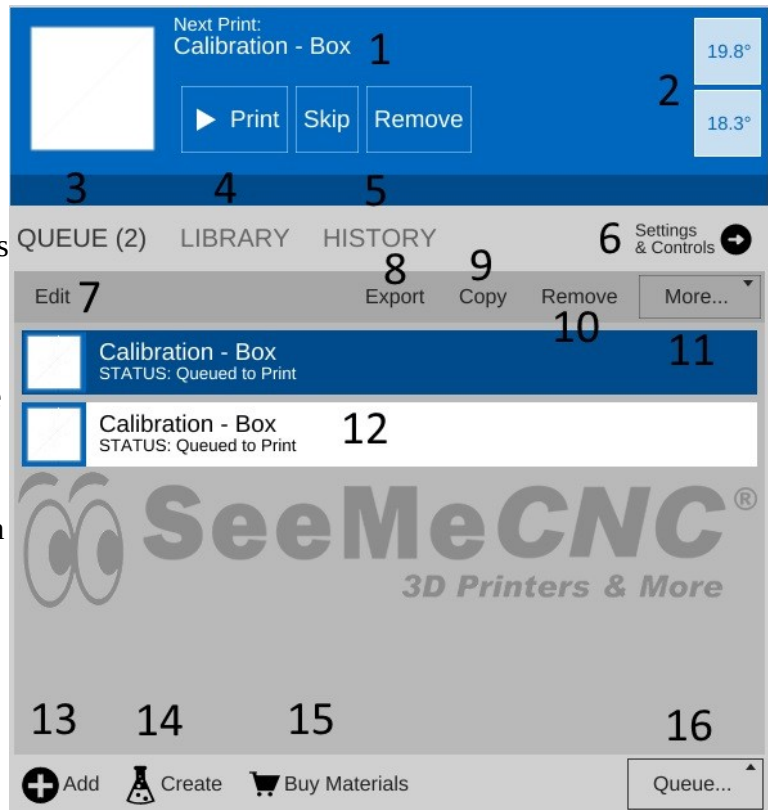

Fig. 2.1-9: Status & Print Queue Pane.

9. The **Copy** button will make copies of the currently selected item in the print queue.
10. The **Remove** button will remove the currently selected item in the print queue.
11. The **More** drop-down will allow you to send the currently selected item to another device, or to the print Library.
12. This is where you'll see items that are currently in your Queue.
13. The **Add** button will allow you to add objects or G-Code files to the print queue.
14. The **Create** button displays a list of available plug-ins that are used to create printable objects right inside of MatterControl.
15. The **Buy Materials** button will open a browser and point it to the SeeMeCNC store.
16. The **Queue** button opens a menu list that will allow you to export the current file and perform other operations on the print queue.

The right half of the MatterControl interface is occupied by a 3D view of your build platform and what objects are currently loaded and ready to print.

1. View manipulation controls – Reset View, Rotate, Pan, and Zoom. By default, the 3D view will show a rotating display of the part. You can stop the rotation by clicking anywhere in the 3D view window.
2. The 3D and Layer view controls allow you to switch between the 3D view (shown) and the Layer view. The layer view shows you the path the print head will take as your part is printed. The layer view won't display anything until the part you want to print has been “sliced”.
3. The object currently ready to print.
4. This is a representation of your Rostock MAX v2's print bed. As long as your object fits within the circle, you should be able to print it!

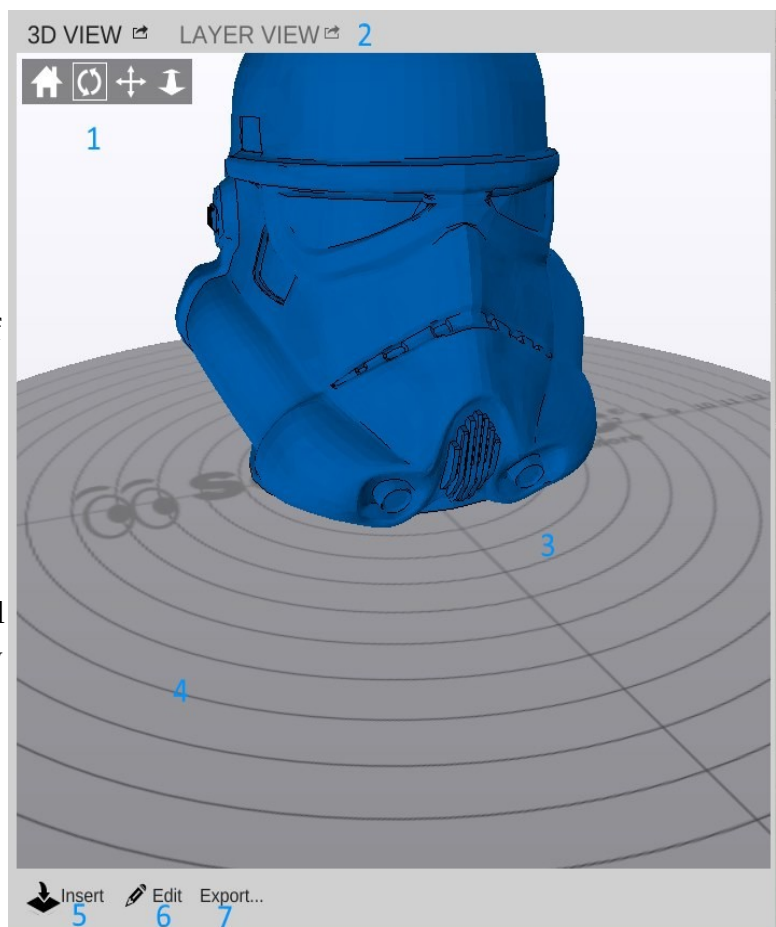

Fig. 2.1-10: The Model Pane

5 & 6. The **Insert** and **Edit** buttons allow you to add objects to the current print job as well as manipulate them.

7. The **Export** button allows you to save the current state of the build plate in a few different file formats. This feature will allow you to save GCODE to the SD card for stand-alone printing!

Go ahead and click on the **Settings & Controls** button. The Settings & Controls pane allows you to directly control your printer, change its configuration and change slicer settings.

The image on the right shows the “Controls” portion of the display. (If you look at the top, you'll notice “CONTROLS” is highlighted.)

There's a lot going on with this pane, so I'll go into more detail with it as you need to use it as well as in a later chapter.

Let's move on to getting your printer ready to calibrate!

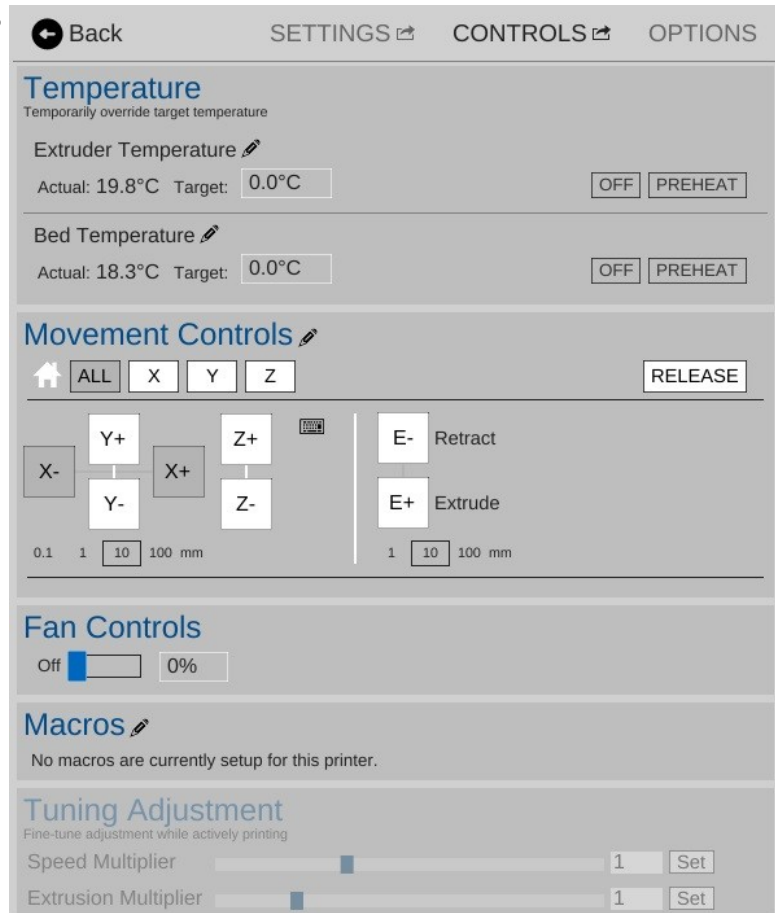

Fig. 2.1-11: The Settings & Controls Pane.

2.2 – Initial Function Tests

Before the calibration process can begin, we need to perform a test of the end-stop switches to make sure that they're functioning correctly. In order to perform this test, you'll need to be able to directly “talk” to the Rostock MAX v2. Click on the **Options** button as indicated below.

Click on the **SHOW TERMINAL** button. This will open up the terminal screen that we need to use to directly communicate with the printer. When the terminal window first opens, you'll see it displaying information that's coming from the printer. This data is being processed by MatterControl to update the temperature displays, etc. The terminal is easier to work with if we turn that information off. To do so, click on the **Filter Output** check-box as shown below.

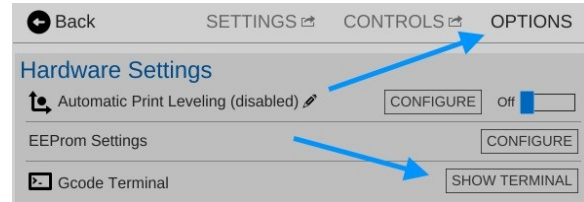

Fig. 2.2-1: Terminal on the Options pane.

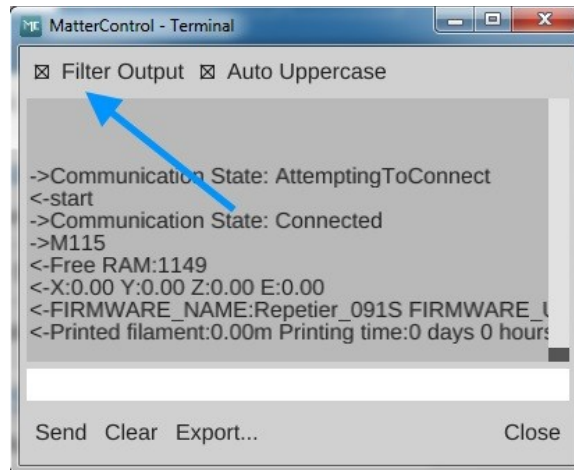

Fig. 2.2-2: Filtering the terminal output.

Now we can send the commands necessary to test the end stop switches. It's important that they operate properly as they're used by the printer to determine the “home” position for the three towers.

Ensure that the end-stop adjustment screws are not in contact with the switches and then enter “M119” into the terminal input box and press the **ENTER** key.

The **M119** command instructs the RAMBo board to return the current state of the three end stop switches.

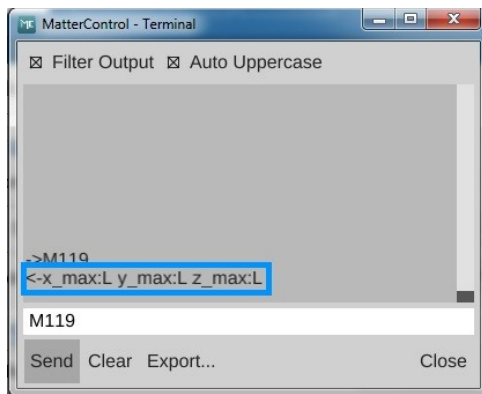

Fig. 2.2-3: Testing the end stop switches.

The three switches are known as “x_max”, “y_max”, and “z_max”. Each one should have an “L” next to it as shown on the left. If any of them show an “H”, check your wiring to ensure that the switch is connected properly at both ends. The printer will not operate properly if any of the end-stop switches are reporting “closed” when they're not.

An “L” next to each label indicates that all three end-stop switches have not been pressed. If you see anything different, please check your wiring as mentioned previously! Now I want you to hold down the switch lever for the X axis and re-send the **M119** command. You should see the **x_max** value change to “H”. Do this for the Y and Z axes. This will ensure the end stop switches are functioning – this is very important for the next step!

Click the **CONTROLS** button to get to the screen where we'll perform the movement tests.



Fig. 2.2-4: To the Controls pane!

The next test we're going to perform involves making sure that the stepper motors on the towers are wired correctly. Every once and a while we'll see a stepper motor with the connector wired correctly, but the internal wiring is *backwards*. Maybe the elves that build stepper motors were having a bad cookie day or something. Let's find out if you won a bad cookie motor!



Fig. 2.2-5: Home Axes.

The next task is to make sure that you can “home” the machine. By clicking on the **ALL** button shown above, it should send all three axes up to the end-stop switches.

With one finger on the power switch, click that **ALL** button! If **any** of the three axes do not head up to the top of the machine, **turn off the power immediately!** You don't want to do any damage to the machine due to an inverted axis. Don't worry though, fixing an inverted axis is **VERY** easy!

If you need to apply this fix, click the **DISCONNECT** button in MatterControl and then open up Repetier-Firmware in the Arduino IDE. Click on the tab marked “Configuration.h”. You may need to increase the width of the IDE window in order to see that tab.

Scroll down until you find a small section marked “// Inverting axis direction”.

```
// Inverting axis direction
#define INVERT_X_DIR true
#define INVERT_Y_DIR false
#define INVERT_Z_DIR true
```

Fig. 2.2-6: Axis directions.

Once you've located this area, I want you to change the entry that corresponds to your misbehaving motor to the opposite of its current setting. If it's currently **true** set it to **false** and vice-versa. If you have more than one, change those as well. For example, if your Y axis Cheap skate headed for the floor when you hit the reset button, you'll change **INVERT_Y_DIR** to **true**. Once you've made your changes, click “File”, “Save” and then hit the Upload icon to send your updated firmware to the RAMBo controller.

Once the upload finishes, click the **CONNECT** button in MatterControl to reconnect to the printer. You'll need to click on the **Advanced Controls** button in order to return to the control screen.

The next test involves moving the axes around to make sure they're free and clear and there's no “bad” noises going on. Make sure that you're on the **CONTROLS** screen and hit the Home All icon line you did before. All three axes should travel to the top of the machine and “bounce” off the end stop switches.

Click the **OPTIONS** button and then click the **SHOW TERMINAL** button.

Send “**G0 Z200 F3500**”. This will move the effector platform down a few centimeters. The idea is to get them off the end stops so we can move things around a bit.

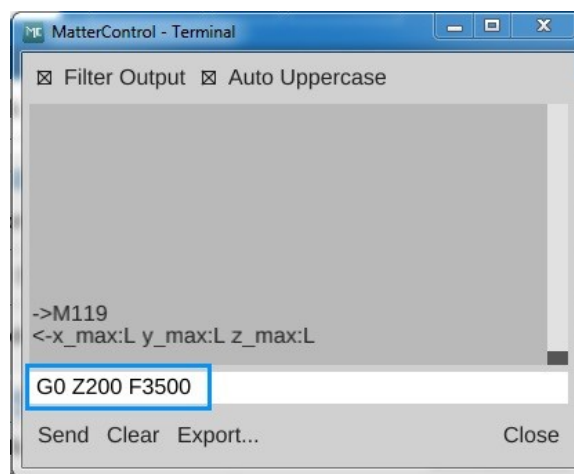

Fig. 2.2-7: Getting some room to move!

Close the terminal window and click on the **CONTROLS** button to return to the control screen.

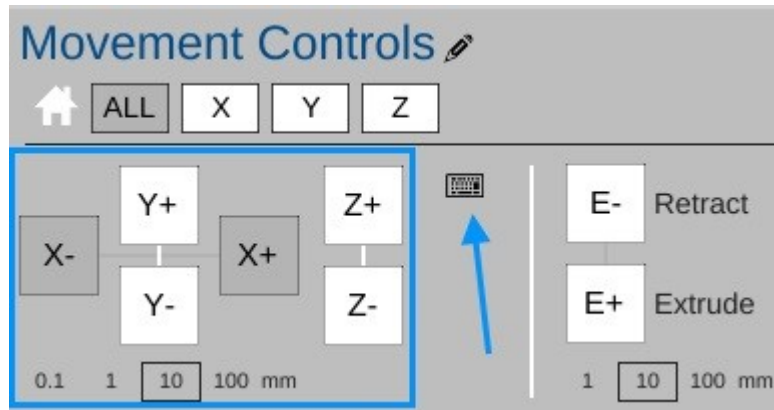

Fig. 2.2-8: Manual travel controls.

The manual travel controls (outlined in blue, above) will allow you to manually move the effector platform around the operating area. The X axis buttons will move the effector platform to the left (X-) and right (X+). The Y axis buttons will move the Y axis toward the front of the machine (Y-) and toward the back of the machine (Y+). The Z axis buttons will raise (Z+) and lower (Z-) the effector platform.

The arrow points to a keyboard symbol. When you click on that symbol, you can use your cursor keys to move the effector around just as you did by clicking on the labeled buttons. The Up and Down arrows control the Y axis, the Left & Right arrows control the X axis and the Page Up and Page Down keys control the Z axis.

Under the axis controls you'll see four values with a square box around the "10" value. These values dictate how much to move the effector platform with each click of an axis button. The values are in millimeters. The ".1" value will set the travel distance to 0.1mm and the "100" value will set the travel distance to 100mm.

Experiment with how the machine moves by clicking on the axis controls or use the cursor keys. Be careful not to drive the hot end outside the boundaries. If you accidentally do that, just power the machine off and back on. Click the **DISCONNECT** button and then hit **CONNECT** to re-establish communication between the Rostock MAX v2 and MatterControl. You'll need to re-home the machine before you continue experimenting.

While learning how the motion controls work, please keep the Z height (the distance from the tip of the hot end to the build surface) a few inches above the build platform. We haven't set the Rostock MAX's true Z height yet and you don't want to smash the hot end into the bed by accident.

The last test involves checking the basic function of both the hot end heating resistors and the heated bed. For this test, you're only going to turn them on long enough to verify that they're indeed heating up as they should.

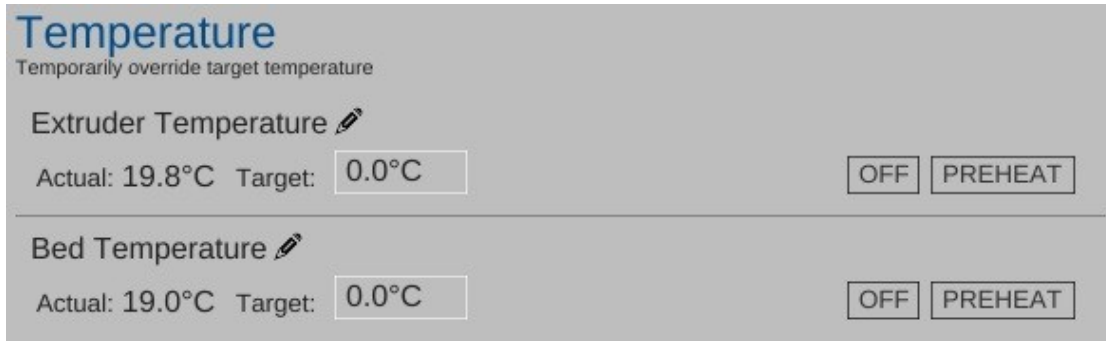

Fig. 2.2-9: Manual temperature controls.

We'll test the hot end first. In the **Extruder Temperature Override** section, click in the **"Target:"** box (where it reads 0.0) and type in "200" and press **ENTER** or click on the **SET** button that appears when you begin typing in the field.

Once you see the **"Actual"** temperature ("19.8C" above) begin to climb, wait a few seconds and then click the **OFF** button to turn it off. Perform the same test with the heated bed by setting the target temperature in the **Bed Temperature Override** to 50. Note that because the bed has such a large surface area, it will heat much more slowly than the hot end.

You'll notice that after you turn the heaters off that the temperature will continue to climb for a short time. This is normal behavior. It's just like a burner on a stove. When you turn it on for a short time and turn it off again, it'll still continue to heat for a short time until the surrounding air can cool it down. As the bed heats, you should see the **"BED HEAT"** LED illuminate. If it doesn't and you see the bed heating on the LCD, check the polarity and wiring of the LED.

Okay, now that you've spent the last 5 minutes (Who am I kidding? You've been poking at it for at least an hour, giggling like a little kid. Your dignity is the first casualty of having your own 3D printer. Don't worry, you're in good company.) moving the hot end around and seeing how it works, now it's time to get it calibrated so you can begin printing your army of squirrels and Yoda heads!

In order for the mechanical calibration to be accurate, we need to do the steps with the Rostock MAX at operating temperature. This means that both the hot end and heated bed must be at the temperature they'd normally be at while printing.

2.3 – Setting the Z Height

Bring your hot end and heated bed up to operating temperature. Set the hot end temp to 190C and the heated bed to 55C. We want the hot end and bed to expand to “normal” so we can get a fairly accurate measurement here.

Once the hot end and bed have reached their target temperatures, push the knob in on the LCD controller. This will take you to the LCD menu. Turn the shaft counter-clockwise until you reach the “Advanced Settings” entry and then click the button to select that option.

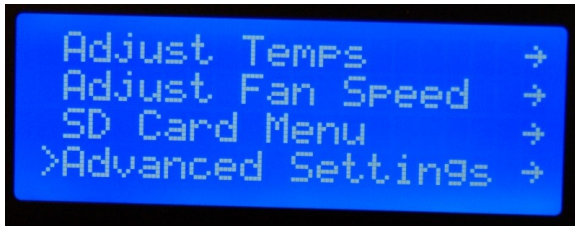

Fig. 2.3-1: Advanced Settings.

Rotate the shaft counter-clockwise until you reach the “Calibrate Z Height” option and click the button.

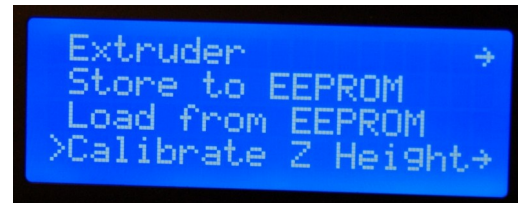

Fig. 2.3-2: Calibrate Z Height.

Rotate the knob counter-clockwise again and choose the “Home Towers” menu option and click. This will send the Rostock MAX to the home position. This is the same as sending **G28** to the printer or clicking the “Home All” icon in MatterControl. After the homing process finishes, select the “Z-Position” option and click.

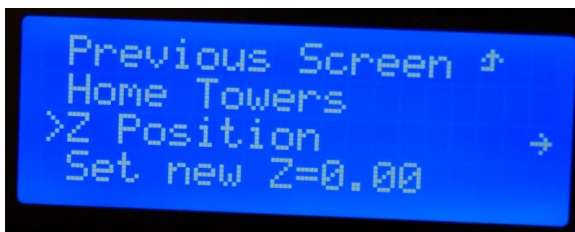

Fig. 2.3-3: Z Position.

When you click on the Z-Position option, you'll see a display similar to that shown below.

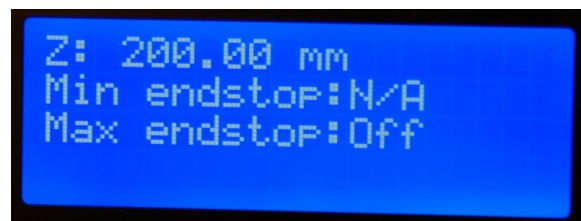

Fig. 2.3-4: Adjusting the Z height.

You control the height of the effector platform by turning the shaft on the LCD panel. Turning it counter-clockwise will lower the nozzle, and turning it clockwise will raise it.

If you turn the shaft quickly, you'll get large changes and if you turn it slowly, one step at a time, the change will only be 0.01mm per click. **Please be careful not to accidentally burn yourself on the heated bed or the nozzle!**

Rostock MAX v2 User's Guide

Turn the shaft counter-clockwise until you're about 1/2" from the bed surface. Place a sheet of paper on the bed, under the nozzle. Lower the nozzle slowly until moving the paper around causes it to drag a little bit on the nozzle tip. You want it close enough that you can push the paper under the nozzle, such that it *almost* prevents you from pushing the paper under the nozzle.

When you've reached that point, press the knob to return to the LCD menu and then select the "Set new Z=0.00" option. This will set the correct Z-Height for your Rostock MAX v2.

2.4 – Motion Calibration

Now we need to adjust the end stops in order to calibrate the effector platform. This ensures that the effector platform your Rostock MAX v2 achieves an accurate nozzle height and parallel travel across the entire bed surface.

To make this process easier, we're going to create a macro within MatterControl.

In order to create a new macro you'll need to open the macro editor. Click on the little pencil icon shown on the **CONTROLS** screen.

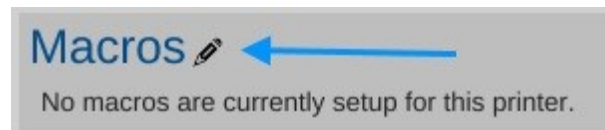

Fig. 2.4-1: Starting the Macro editor.

This will bring up the Macro Editor, as shown above. Click on the “**ADD**” button to create a new macro.

You're going to name the new macro, “Tower Cal”.

In the Macro Commands box, you'll enter:

; Rostock Max Tower end-stop calibration script

G28

G1 Z0.2 F15000

G4 S5

G1 X-77.94 Y-45 Z0.2 F2000

G4 S5

G1 X0 Y0 Z0.2

G1 X77.94 Y-45 Z0.2

G4 S5

G1 X0 Y0 Z0.2

G1 Y90 Z0.2

G4 S5

G1 X0 Y0 Z0.2

If you're reading this as a PDF, you can easily copy & paste the G-Code into the editor window. If you do this, it will insert a blank line between each line of G-Code. You can remove these blank lines.

Click the **Save** button to save the new macro.



Fig. 2.4-2: Macro Editor.

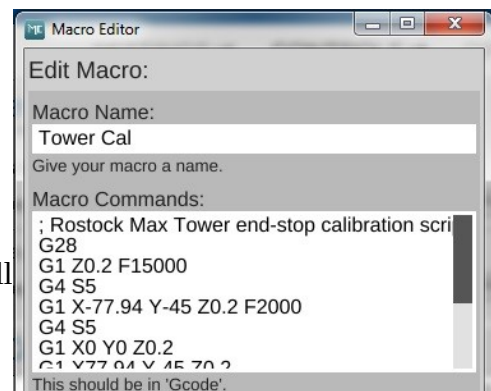

Fig. 2.4-3: Calibration macro.

When you're done, click the **Close** button on the Macro Editor. The **CONTROLS** screen should now have a macro display that looks like the figure below.



Fig. 2.4-4: Available macros.

The macro will become a button you can click on. **DO NOT CLICK IT YET.**

In order to make the calibration as accurate as possible, you'll need to bring both the heated bed and the hot end to operating temperature. Set the Extruder temperature to 190C and the Bed temperature to 55C just as you did for setting the Z height.

Open the EEPROM editor and check the values shown below. If the **Diagonal Rod Length** parameter isn't set to 290.8, please change it to that value. The starting position for the **Horizontal Radius** is 144. **[If you're working with an older v2 or v1 with the u-joint based arms, your Diagonal Rod Length should be 269 and your starting Horizontal Radius should be 130.25]**

Diagonal rod length [mm]	290.8
Horizontal radius [mm]	144

Fig. 2.4-5: Diagonal Rod & Horizontal Radius settings.

Make sure you save your changes before you move on.

In order to help you calibrate the Rostock MAX v2, SeeMeCNC has created a neat video that illustrates the entire process from beginning to end. In the video they're using the SeeMeCNC Orion printer, but the technique is the same for the Rostock MAX v2. When you see reference in the video to running the "TOWER.GCO" file, you'll instead click on the **Tower Cal** button that you just created the macro for. They're the same thing, just executed differently.

<https://www.youtube.com/watch?v=g3CqWxTcV38>

When you click on the **Tower Cal** button, it will execute the script you just entered. The script will move the nozzle to 0.2mm above the center of the build plate and pause for five seconds. It will then move to the X tower, then the Y tower, then the Z tower, and finally will return to center.

You may notice an odd "arc" motion as the nozzle travels from point to point. This is a mathematical phenomenon within the firmware and won't affect your calibration. You can safely ignore it.

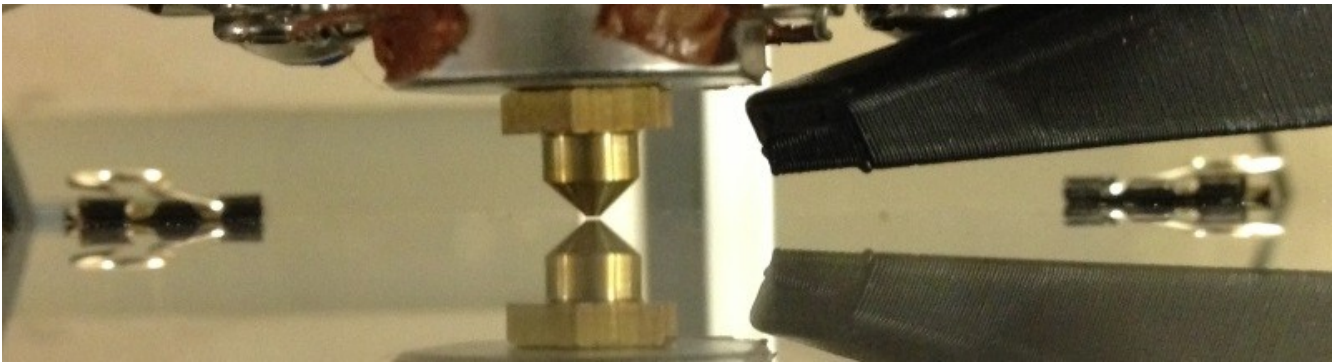

Fig. 2.4-6: Nozzle at the center, 0.2mm above the glass.

As the script runs, your focus should be on the nozzle where it pauses. You want to compare the gap at the tower base to the gap at the center.

If the nozzle at the tower base is higher at the pause point in comparison to the center, you'll want to turn the screw for that tower's end-stop counter-clockwise. Think "Turn Left to Lower".

If the nozzle at the tower base is lower at the pause point in comparison to the center, you'll want to turn the screw for that tower's end-stop clockwise. Think "Turn Right to Raise".

Repeat this process for each of the three axes. You can adjust a single axis at a time, or you can do two or all three. Doing all three at once may make you crazy unless you're a good juggler. Set the Z height and **Tower Cal** macro each time you make a change to an end-stop screw.

When you're done, you need to re-set the Z height as it will have changed due to the calibration process. Once you've re-set the Z height, run the **Tower Cal** macro again. Pay close attention to the distance between the nozzle and the glass bed.

If from the center position, the nozzle goes *down* toward the glass at **all three towers**, you'll need to change the **Horizontal Radius** value in the EEPROM. Open up the EEPROM table editor and scroll down until you see the field marked below.

Horizontal radius [mm]

144

Fig. 2-4.7: Horizontal Radius.

You'll want to **raise** this figure by 0.2. Run the **Tower Cal** macro after each change to check the effectiveness of the change.

If from the center position the nozzle goes **up** from the glass at **all three towers**, you'll want to **lower** the Horizontal Radius by 0.2. Run the **Tower Cal** macro after each change to check the effectiveness of the change.

After doing this, you will see any changes where one tower may be higher than the other. If this is the case, go back and re-adjust the end stop screws.

It can typically take anywhere from 5-10 iterations of the calibration process in order to get the gap to remain the same at all three pause points compared to the center point. Once the gap is the same at each tower compared to the center, the machine is calibrated and ready to print.

2.5 – Verifying Extruder Stepper Operation

Go to the **CONTROLS** pane in MatterControl and click the “PLA” button that's in the “Extruder Temperature Override” box. The hot end needs to be heated in order to perform this next test. The reason for this is that the firmware is designed such that it will not permit extrusion if the hot end is cold.

Once the hot end has reached the target temp (190C in this case), click the “E+” button to extrude some filament.

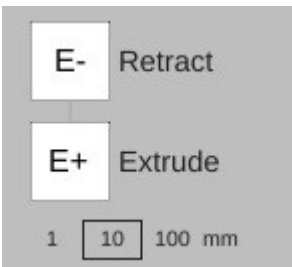

Fig. 2.5-1: Extrude Filament control.

Watch the knob on the extruder when you click that button. You should see the knob slowly turn counter-clockwise. If it's turning clockwise, you'll have to make a change in the firmware. It's a very simple change and you shouldn't have any problem at all doing it.

If you've got backwards-running stepper motor, you'll need to open the Arduino IDE and make a single change in Configuration.h. Look for the following line:

```
#define EXT0_INVERSE true
```

You'll find it on or close to line #195 in the file. Whatever the value is set to, invert it. If it's true, change it to “false”. If it's false, change it to “true”. Save your changes and then upload the firmware to the RAMBo. **Make sure you've got MatterControl disconnected or the Arduino IDE won't be able to talk to the board.**

2.6 – Extruder Calibration

The last task you'll need to perform before you can load plastic in to the machine is to correctly set the steps per mm (“E-Steps”) for the extruder. Open up the EEPROM configuration editor and look for the label shown below. Your default starting point should be 92.65.



Fig. 2.6-1: Extruder steps per mm.

Rostock MAX v2 User's Guide

This value dictates the number of steps that the stepper motor must rotate in order to feed 1mm worth of filament to the hot end. The figure supplied will get your e-steps very close to ideal, but extra fine tuning should be done. I *highly* recommend that you check out the “E Steps Fine Tuning” section of Triffid_Hunter's excellent calibration guide. It can be found here:

http://reprap.org/wiki/Triffid_Hunter%27s_Calibration_Guide

The other portions of his calibration guide doesn't really apply to the Rostock MAX v2, so it's not necessary to read unless you're simply curious.

WARNING: At no time should you allow your hot end temperature to exceed 245C! The PEEK section of the stock hot end will melt at 247C, requiring its replacement!

3 – First Print: PEEK Fan Shroud

For your first (and second!) prints, you're going to need to have ABS filament handy. This is because the PEEK and Layer fan shrouds can be exposed to temperatures that would turn PLA shrouds into a gooey mess. You're also going to need the 25x25x10mm PEEK fan itself.

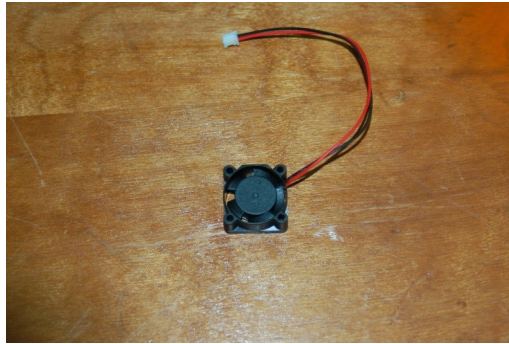

PEEK Cooling Fan.

3.1 – Configuring the Slicer

The process of converting a 3D model into something you can print is called “slicing”. The software used for this process is typically called a “slicer”. Essentially a slicer cuts up your 3D model into hundreds (sometimes thousands!) of tiny slices that are then converted into code that the printer controller can understand. MatterControl contains three slicing “engines”: Slic3r, CuraEngine and MatterSlice. I'm only going to cover the MatterSlice engine configuration for right now.

Before you can begin your first print, you're going to customize your first material profile!

Click on the **SETTINGS** button. This will bring up the materials pane.



Fig. 3.1-1: Materials pane.

Click on the Toolbox icon pointed to by the arrow. This will open a list of your currently configured materials.

Click the edit field for the ABS configuration. When the **Presets Editor** window appears, click on “**Duplicate**”. This will create a new preset called “ABS (copy)”.

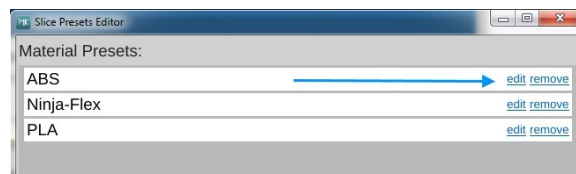

Fig. 3.1-2: Material presets.

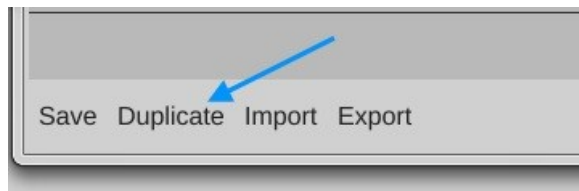

Fig. 3.1-3: Duplicating a preset.

Click in the box that holds the name of the profile and change it to something that's descriptive of the material. Since I'm using a navy blue ABS filament I got from SeeMeCNC, I'm naming this preset "SeeMeCNC Navy Blue ABS 1.75"

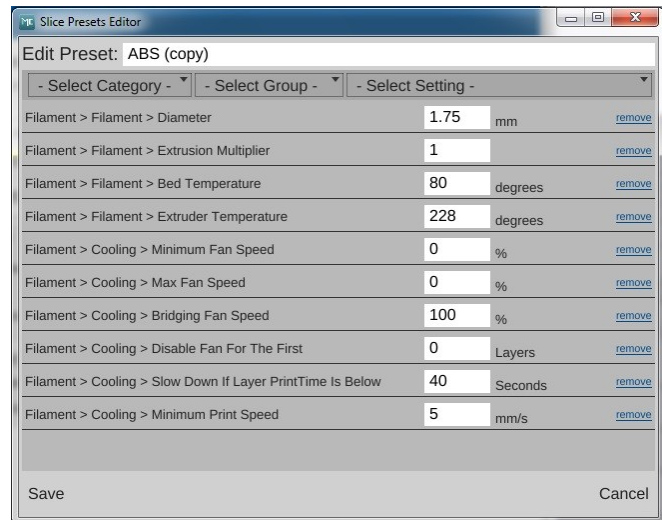

Fig. 3.1-4: Copied preset.

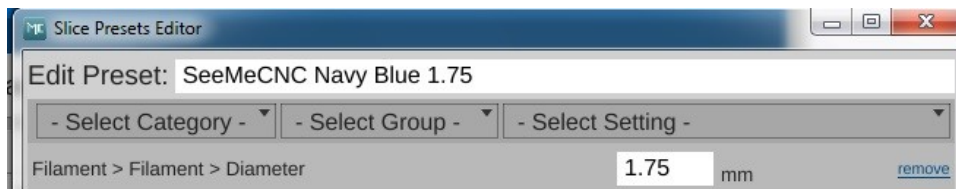

Fig. 3.1-5: A new material preset!

Now before you can save your new preset, you need to get a good idea of the actual diameter of your filament. This is important to know in order to get good print results.

I want you to cut off about 2 meters of filament from the spool you're going to use to print the fan shroud. Using your digital caliper, take 5 measurements along the length and record each one. When you're done, calculate the average filament diameter and put that figure into the Diameter size field. It may be less than 1.75mm, but shouldn't be any more than 1.8mm. If you have any measurements of 1.8mm or greater on your filament, it may bind in the hot end. In my case, the filament average was 1.72, so that's what I entered.

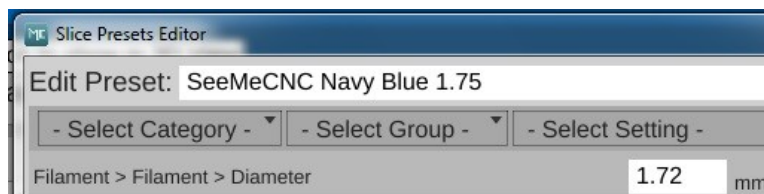

Fig. 3.1-6: Updated filament diameter.

After you've updated the filament diameter, click **Save** to commit your changes. When the editor window is dismissed, you'll see your new material preset in the list!



Fig. 3.1-7: New material preset!

Click **Close** to dismiss the **Presets Editor** and we'll move on to the next step, printing your first part!

3.2 – Printing The PEEK Fan Shroud

If you downloaded the MatterControl presets file, you can skip downloading the file from Repables.

Go here: <http://repables.com/r/620/> and click the “Download” link. When the download is finished, unzip the file. This is the STL file that MatterSlice will process and turn into your first print!

When you've got the file downloaded, you can load it into MatterControl by clicking on the “**Add**” button and selecting the STL file you want. Note that if your Queue shows the example parts from MatterControl, click the **Remove** button to get rid of them.



Fig. 3.2-1: Loading an STL file.

Once the open file dialog opens, navigate to where you unpacked the file.

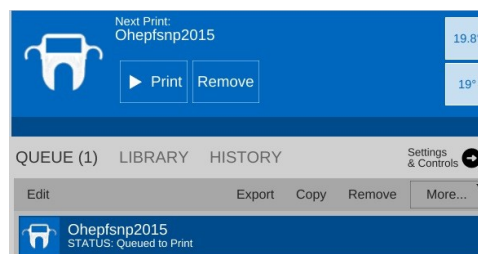

Fig. 3.2-2: Part loaded!

Now that you've got the file loaded, we need to load filament into the printer!

3.3 – Loading Filament

It's extremely simple to load filament into the EZStruder. Just place your index finger on the top of the extruder and your thumb on the tension lever (marked by the arrow below). Press the tension lever down and feed the filament by hand along the path marked by the green arrow. There is a small opening behind the tension lever that the filament will enter into the extruder through.

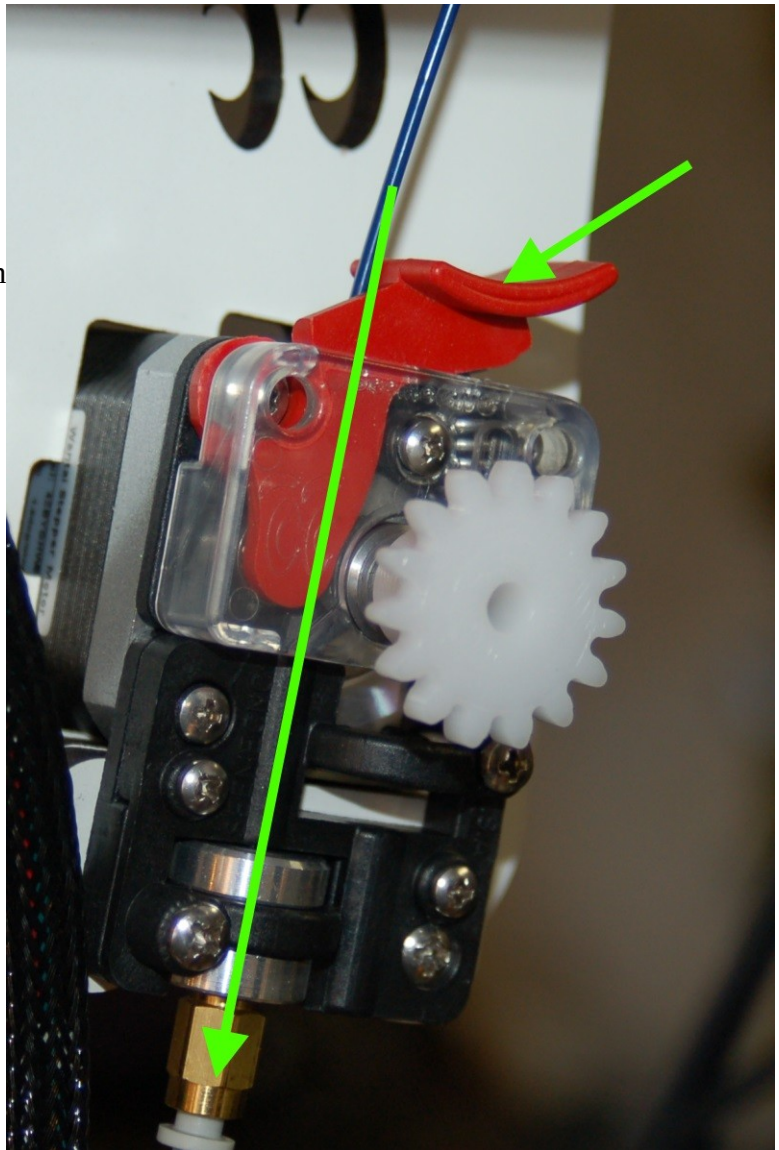

Fig. 3.3-1: Loading filament.

Continue to manually feed the filament until it passes through the other push-fit connector on the hot end.

Now you'll need to heat the hot end in order to prime it with filament. Once the hot end reaches the target temperature, I want you to start using the manual Extrusion button to feed filament into the hot end.

In the figure to the right, you'll see the control panel for the extruder. In order to safely feed the hot end, make sure that you've selected "10" in the settings below the **E+** button. Click the **E+** button to begin feeding filament through the hot end. You may have to click the button a number of times to get filament coming out of the hot end, but you'll want to wait for the extruder to stop moving before you click it again.

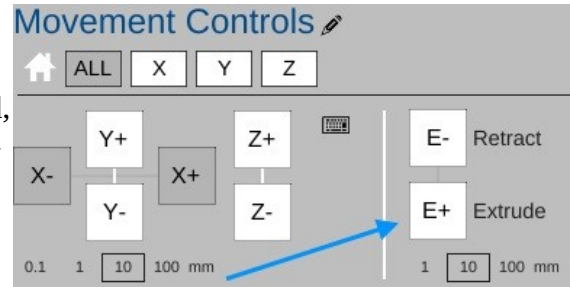

Fig. 3.3-2: Extruder control.

Once it does begin to feed, go ahead and click the **E+** button a few more times just to get the extruder all nice and primed.

I recommend that you extrude 20-30mm of filament each time you start up the printer for the day. This ensures that the hot end is primed and you have no jamming issues.

3.4 – Preparing the Heated Bed

ABS won't stick to bare glass. In order to get the ABS to stick, you're going to need to apply two thin layers of glue to the bed. Remember back in the “need to have” list, I listed the Elmer's “Disappearing Purple” glue stick? This is where you're going to use it.

You'll want to apply two perpendicular layers of glue on to the heated bed. Follow the simple pattern shown on the right. The green lines represent the first layer and the red lines represent the second. The idea is to lay down a thin, even layer with no spaces between each “lane” of glue. Let the base layer completely dry before applying the second layer. Let THAT layer dry before starting a print.

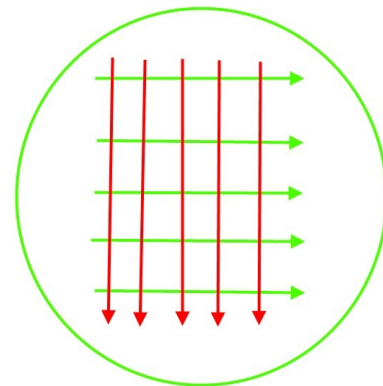

Fig. 3.4-1: Glue application.

3.5 – Printing the PEEK Fan Shroud

Check on the **Slice Settings** pane to make sure that you've got “MatterSlice” chosen for the slice engine, “STANDARD” chosen for Quality, and “ABS” chosen for Material. ***Make sure that the filament you have loaded in your printer IS ABS! Running PLA at ABS temperatures without the PEEK fan installed will cause the hot end to jam!***

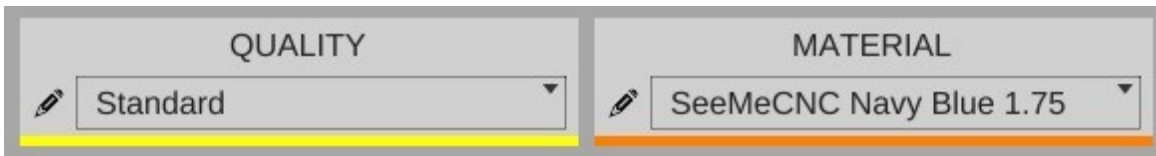

Fig. 3.5-1: Correct slice settings.

Now that you've gotten everything loaded and prepped, starting the print is as simple as clicking on the “**Print**” button.



Fig. 3.5-2: Starting the print job.

When you click the **Print** button, the hot end and the heated bed will begin to heat. The hot end will reach its target temperature first because it has much less mass to heat than the heated bed. The heated bed can take up to 10 minutes or so to reach its target temperature.



Fig. 3.5-3: Heating up!

Once both the bed and hot end are hot, the printer will home and the print job will begin!

Rostock MAX v2 User's Guide

Right before the printer begins to print, the RAMBo controller will “chirp” the LCD speaker and you'll see a text warning on the LCD controller to keep your hands away. There will be a short delay after this and the print job will begin!

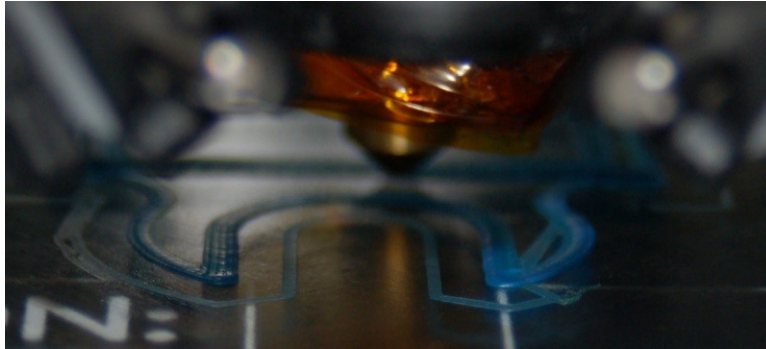

Fig. 3.5-4: The first layer.

The print will take roughly an hour to complete. When the job finishes, MatterControl will issue a bell sound and the machine will home itself. (It's actually more of a “Hey! YOUR TOAST IS DONE!” dinging sound, but you get the idea...)

To the left is a photo of the PEEK fan shroud I printed. It's got a few defects, mostly due to a slight amount of over-extrusion. As you get more familiar with the Rostock MAX v2 and 3D printing in general, you'll learn how to fix issues like this to get excellent prints!

After the print job is complete, the power to the hot end and the heated bed will be turned off. When the heated bed reaches around 40C, you'll probably hear a cracking sound as the part separates from the bed.

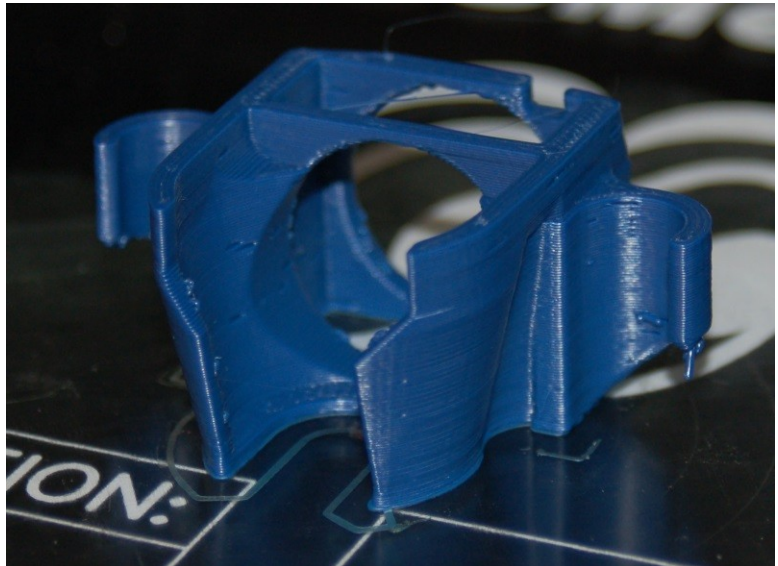

Fig. 3.5-5: Completed PEEK Fan Shroud.

Even if you don't hear this sound, the part should come free of the bed pretty easily after the bed has had a chance to cool.

3.6 – Installing the PEEK Fan and Shroud

Before you can install the PEEK fan shroud, you're going to have to wait for the hot end to cool to room temperature. You don't want to burn yourself while installing the shroud.

While you're waiting for the hot end to cool down, go ahead and install the 25x25x10mm fan into the shroud. I'll warn you right now – it's going to be a VERY tight fit. The issue is that the fan is manufactured to a bit of a larger size than its nominal 25x25x10 size indicates. One of the issues this presents is that the thin walls of the fan frame can deform and prevent the fan blades from moving. This can be solved by sanding just a tiny amount from the sides of the fan as shown below.

It looks like I removed a lot of material, but it's really only about 0.25mm.

Take a little off at a time and check for fit each time. You'll eventually reach a point where you can blow on the fan blades and they'll spin without striking the inside wall of the fan frame itself. Take care not to remove too much at one time – you don't want the fan to be loose in the shroud.



Fig. 3.6-1: Thinning down the fan.

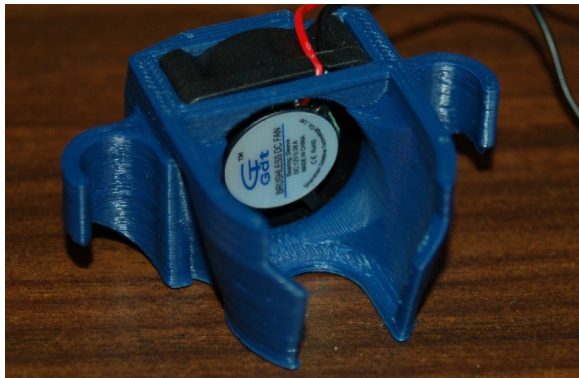

Fig. 3.6-2: Fan installed, inside view.

Make sure you've got the fan oriented exactly as shown. You want the label of the fan facing the space where the hot end will be. The power wires for the fan should rest in the notch provided.

You also want to make sure that the fan is fully seated. The fan shroud fits between the effector platform and the hot end mount.

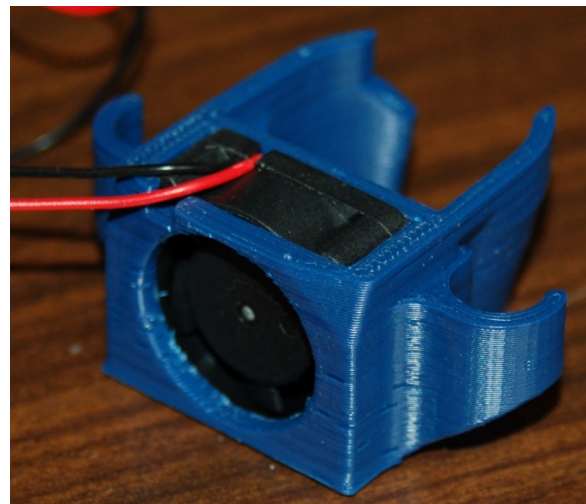

Fig. 3.6-3: Fan installed, outside view.

In order to install the fan, you'll have to remove the arms from the effector platform. Release the arms at the effector end and put the ends to either side of the tower as shown. By leaving the carriage end spring clip in, the arm ends will grip the extrusion lightly. This helps when you're re-assembling things. I would also recommend you lay some cloth on the heated bed to protect it.

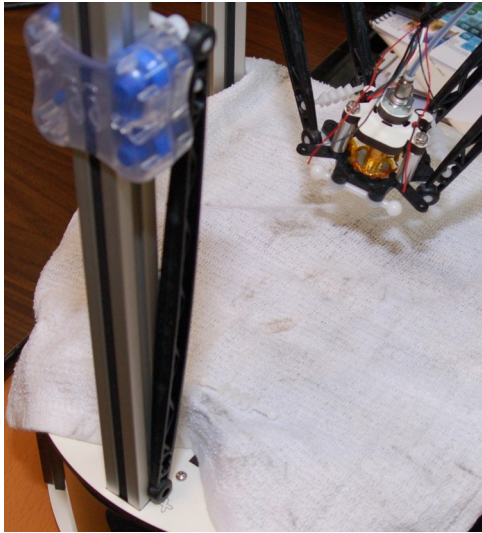

Fig. 3.6-4: Removing the arms.

Once you've got the arms removed from the effector platform, you can slide the fan into the “back” of the hot end assembly. The location is shown below. You may need to rotate the hot end so that the sides of the fan shroud can easily pass between the hot end's power wires and the hot end itself.



Fig. 3.6-5: Fan location.

You do not want to trap a power wire between the fan shroud and the hot end, so make sure those wires clear.

You should be able to insert the fan & shroud as shown on the right. If it's a bit too tight to fit, loosen the three screws that hold the hot end to the effector platform. When the fan shroud is fully inserted, the “arms” of the shroud should be in full contact with the aluminum spacer on either side. Don't forget to re-tighten the screws once you've got the fan installed.

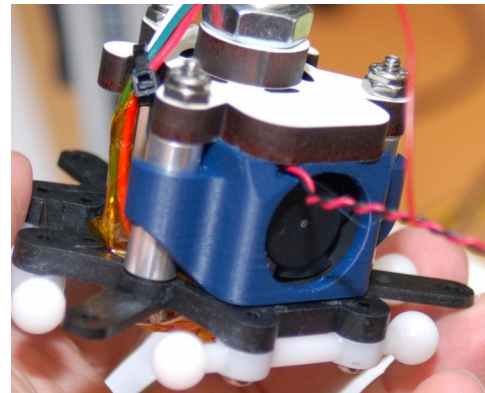

Fig. 3.6-6: Shroud installed.

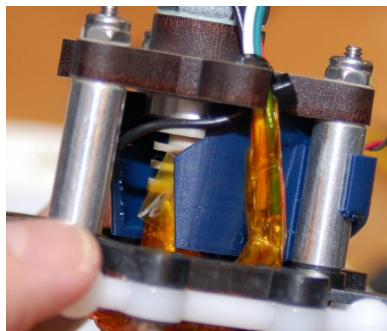

Fig. 3.6-7: Side view of the shroud.

Now you can re-mount the arms on to the effector platform. As you re-install each arm pair, move its carriage down to the bottom. This will have the hot end in the inverted position when you're done, making the wiring job a bit easier to accomplish.

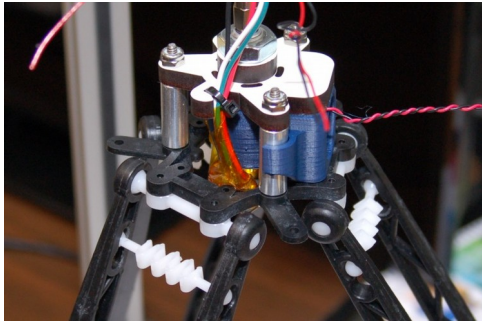

Fig. 3.6-8: Ready to wire!

Once you have all the arms on, you can wire up the fan. The PEEK fan wires are the pair you knotted. Un-knot and strip about 1/2" of insulation. Cut off the connector on the 25mm fan (if present) and strip those as well. I recommend against shortening the wires – you may want to install a connector on them that will allow you to remove the hot end or fan without cutting wires. Splice the wires as you did with the extruder motor wiring and cover the joint with Kapton tape as shown.

Move the arms one at a time back to their normal position. Note that you don't want to move the carriages quickly. The stepper motors can generate power and damage the RAMBo if they're moved too quickly.

The PEEK fan shroud is “virtually” linked to the hot end power. You should be able to see the fan running as soon as you start heating the hot end.

Do that now to make sure the fan operates. When you run a print job, the PEEK fan will continue to run even after power has been removed from the hot end. It will continue to run until the hot end temperature falls below 50C.

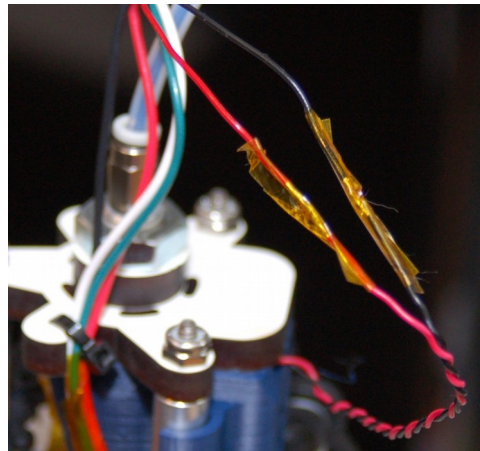
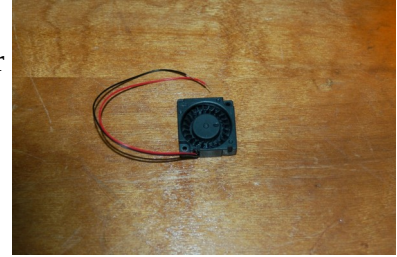

Fig. 3.6-9: All done.

4 – Second Print: Layer Fan Shroud

If you plan on printing in PLA or other materials that can benefit from a cooling fan (NOT ABS!), you'll want to print the layer fan shroud. The layer fan model can be downloaded from Repables, <http://repables.com/r/621/>.

It's specifically designed to mount on the effector platform and uses the included 30mm squirrel cage fan.



The Layer Fan.

Download, extract and load the layer fan model into MatterControl, just as you did for the PEEK fan. The printing parameters are the same. Make sure you've got the same slicing configuration you used as last time and hit the **Print** button!

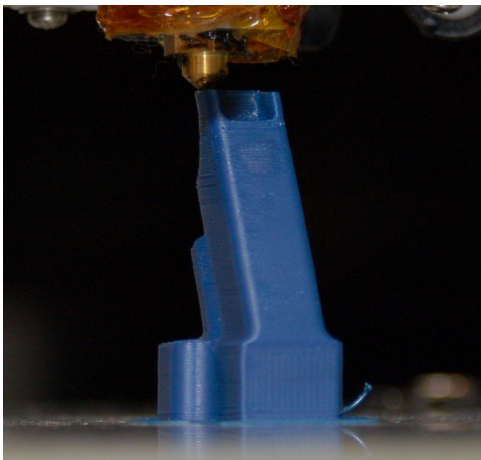

Fig. 4.1-1: Almost done!

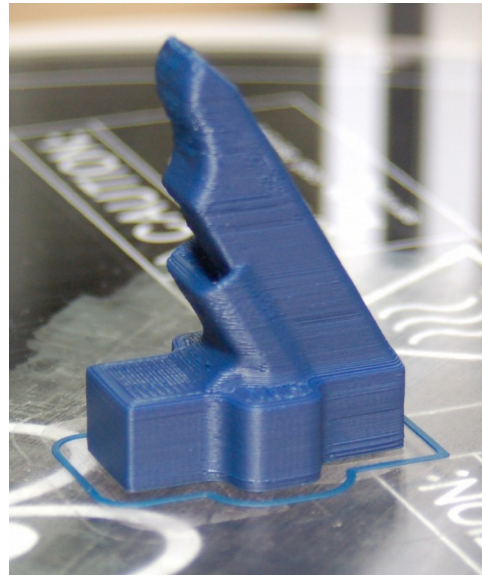

Fig. 4.1-2: Completed fan duct.

When you're able to remove the part from the print bed, insert the tiny squirrel cage fan into the shroud as shown below.

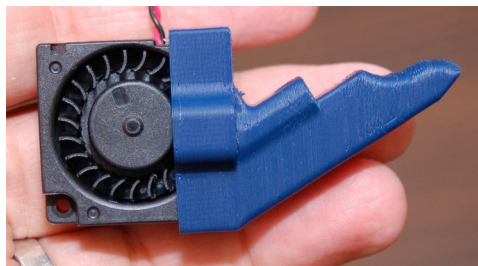

Fig. 4.1-3: Fan installed in the duct.

The effector platform provides three mounting locations for the layer fan. Yes, you can install three of them if you really want. :)

With the machine powered off, slide each Cheapskate down to the base of the tower so that your hot end is at the top of a pyramid formed by the three arms. Lay a washcloth or towel on your heated bed to protect it while you're working on the hot end.

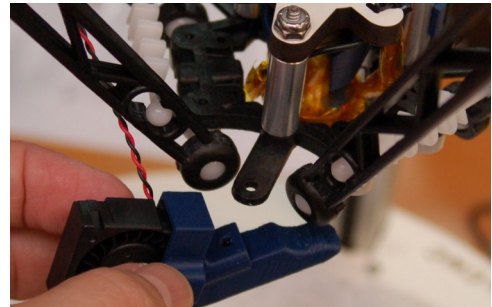

Fig. 4.1-4: Mounting tab.

Choose a mounting point and test fit the shroud. It should be a snug fit, but if it won't fit at all, you may need to clean out the tab pocket with a razor knife.

Leave the fan sitting at the position you chose and solder the fan leads to the last remaining 26ga wire pair coming out of the mesh loom. Cover the solder joints with Kapton tape and use a #4 machine screw to fix the fan shroud into place.

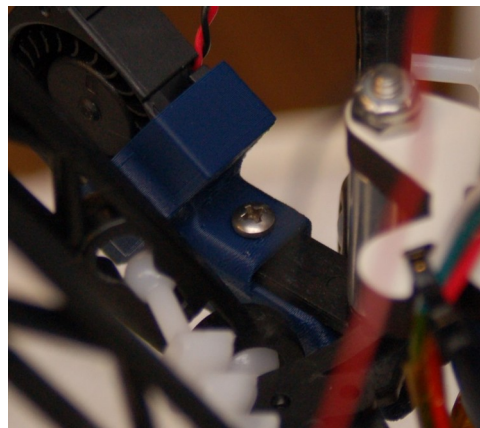

Fig. 4.1-5: Done!

Before you return the hot end to its operating position, turn on the printer and connect MatterControl to it. You're going to test the fan to make sure it works and the fan blades don't rub on the shroud. **DO NOT HOME THE MACHINE WITH THE ARMS INVERTED!**

Click on the **Controls** pane and then set the fan speed to 100% by clicking on “switch” indicated by the arrow in the image below. Once you do this the fan should start at it's default speed of 100%.



Fig. 4.1-6: Starting the layer fan.



Fig. 4.1-7: Fan running.

Rostock MAX v2 User's Guide

The fan should start running at full speed. Make sure that it's spinning the correct direction by holding your hand under the fan shroud to check for moving air. If it's not blowing air, you've likely connected the wires backwards. :) Correct it and try again.

To turn the fan off, just click in the fan speed box and enter "0" followed by ENTER or click on the "Set" button.

With the installation of the layer fan, your Rostock MAX v2 is *totally* complete and you may now...

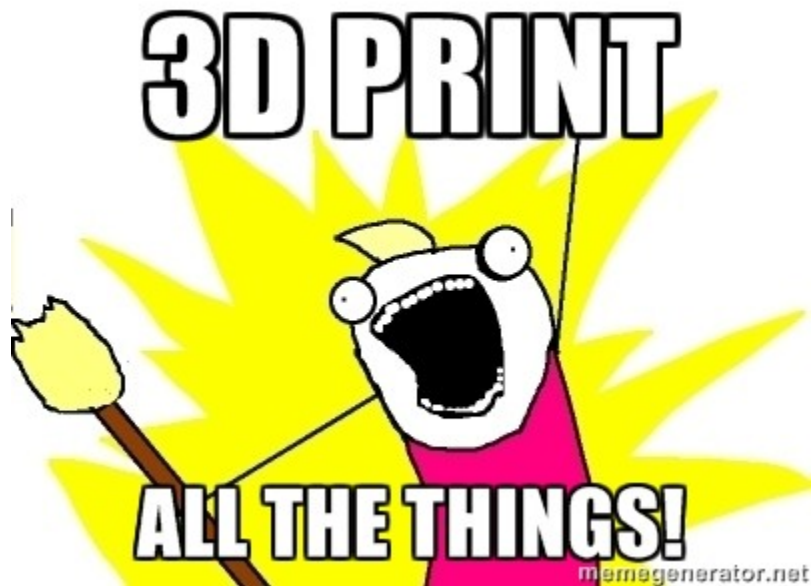

5 – Matter Control Basics: Slicing

MatterControl is a very complete 3D printing package and it's got a LOT of options. Some people can find this intimidating, but I assure you – there's nothing to be worried about!

MatterControl is an integrated host application. This means that it provides everything needed to control the Rostock MAX and to prepare models for printing. The task of preparing a model for printing is called “slicing”. It's a very descriptive term for what is actually happening. In order to print a 3D model, it needs to be converted from a solid object into a series of very thin layers that are in turn converted into G-Code (more on this later). For example, if your print layer height is 0.2mm, the slicing tool is going to “slice” your model into a number of layers – basically the model height divided by 0.2mm. For a tall part, this can mean a LOT of layers!

MatterControl provides three slicers for your use. MatterSlice, CuraEngine, and Slic3r. This guide will only cover the specifics of MatterSlice, but don't let that stop you from experimenting with and using the other slicers! I'll show you how to change the slicing engine later on in this guide.

The final task of the slicer is to translate the sliced layers of model into something called G-Code. G-Code is a simple control language that's used to position the print head and tell the extruder how much plastic to deliver and at what rate. Going into the details of G-Code is beyond the scope of this guide, but if you'd like to learn more you can check out the following resources:

<http://en.wikipedia.org/wiki/G-code> and <http://reprap.org/wiki/G-code>.

For the most part, you'll never directly interact with G-Code, but it's nice to know what's going on behind the curtain!

I want you to click on the **Settings & Controls** button to bring up the **Settings, Controls, and Options** pane.



Fig. 5.1-1: Menu Bar.

Click on the **SETTINGS** link to make sure your display follows (by and large) what you see below.



Fig. 5.1-2: Settings Pane.

The first thing I want you to do is click on the **Show Help** check box that's highlighted by the arrow in the image above. This will turn on verbose descriptions of each one of the parameters available in the Settings page.

I'm going to only cover the “Basic” configuration settings for right now. There's a LOT that goes on to configuring your slicer and the Simple configuration setting allows many of those to be hidden until you're more comfortable with how your printer works.

Layer Height – This parameter tells the slicing engine how thin to make the layers when it slices up the model as I described earlier. A good default layer height is 0.2 or 0.25mm. The lowest practical layer height with a 0.5mm nozzle is 0.1mm. You can go lower than that, but it requires a smaller nozzle diameter. You can also get a lot thicker, but that requires a larger nozzle. If you change the Quality from **Standard** to **Coarse** or **Fine**, you'll notice how the layer height changes.

Here's what the **Coarse**, **Standard**, and **Fine** layer heights look like when printing the little test cube in ABS plastic.

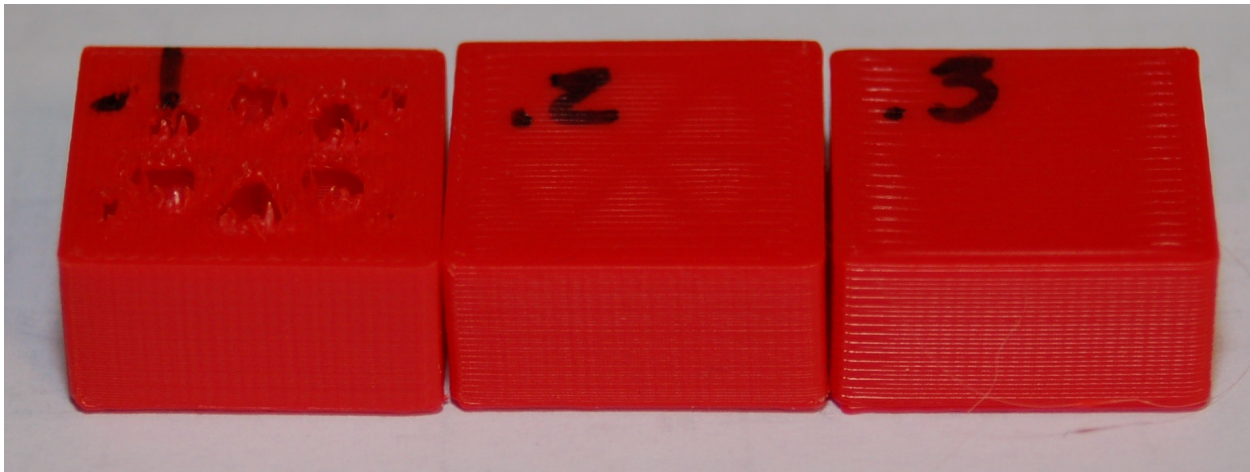

Fig. 5.1-3: Layer height examples.

Starting from left to right, the layer heights are 0.1mm, 0.2mm and 0.3mm. You'll notice that the top layer on the 0.1mm print is kind of ratty and torn up. This is because the number of top layers is set to 3. This is perfectly ok with thicker layer heights, but it should have been set to at least 5 for the 0.1mm layer height that the **Fine** setting uses. You'll learn how to tweak that in a little bit.

You can see how the smoothness of the sides decrease as the layer thickness increases. If you want to print something really quick, you could go up to a 0.35mm layer height. I wouldn't recommend anything over 0.40mm if you're using a 0.5mm nozzle however.

Fill Density – This parameter controls how solid your printed part is. The number is a percentage, from 0 (totally hollow) to 1 (totally solid). The default fill density (also known as “infill”) is 0.2 or 20%. The image below shows what that looks like inside our little test cube.

You can tweak the infill to get a more robust or a lighter part. For most prints, 20% is a good infill value.

Later on I'll show you how to change to a different infill pattern. The one shown on the right is the Triangle pattern.

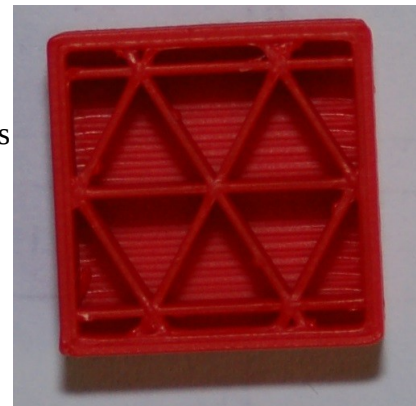

Fig. 5.1-4: 20% infill example.

Support Material – Support material is used when the part you're printing has free-standing features (like the chin on a bust) or another feature that requires it to be physically supported during the printing process. When you check the **Support Material** box, the slicer will automatically design support for the part that's currently (or will be) loaded.

Create Raft – A raft is essentially what it says, a “raft” of material that your part will print on top of. Rafts are most often used when printing a part that is having bed adhesion problems due to its geometry. For example, if you're printing a part that sits on small feet, a raft would come in handy if the initial layers of the feet don't stick very well.

In the image below, you'll see an example of both support material and a raft.

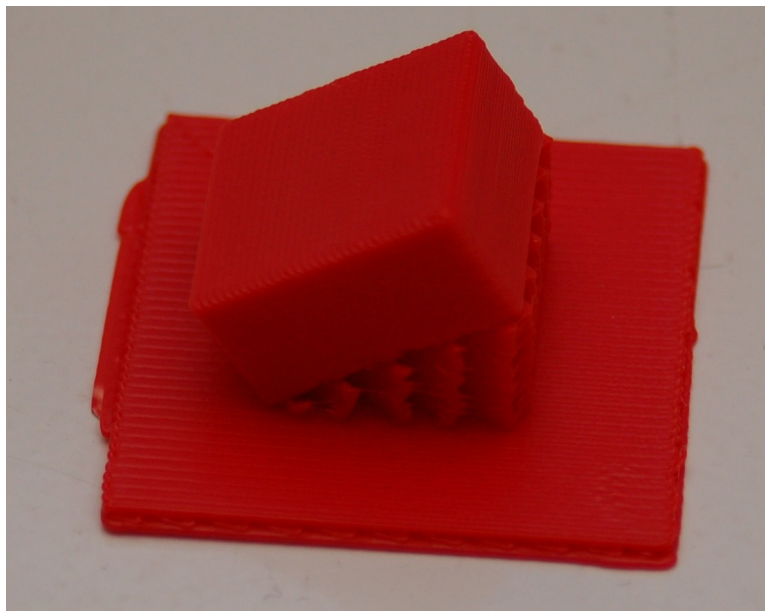

Fig. 5.1-5: Support material and raft.

I took the little test cube and through a little manipulation, printed it tilted at 30 degrees. I took this opportunity to also demonstrate what a raft looks like. This one is exaggerated in its size, but gives a great example of what a typical raft will look like.

The image to the right should give you a pretty good idea of what the part looks like from the side. You can easily see the support material as well as the layer lines that will be at a 30 degree angle when the little cube is laid flat.

Support material is generated in such a way that there is just enough of it there to handle the actual print layer that it will be supporting. In my example, the support material has a 2.5mm spacing between the walls of support material and it uses an infill angle of 45 degrees.

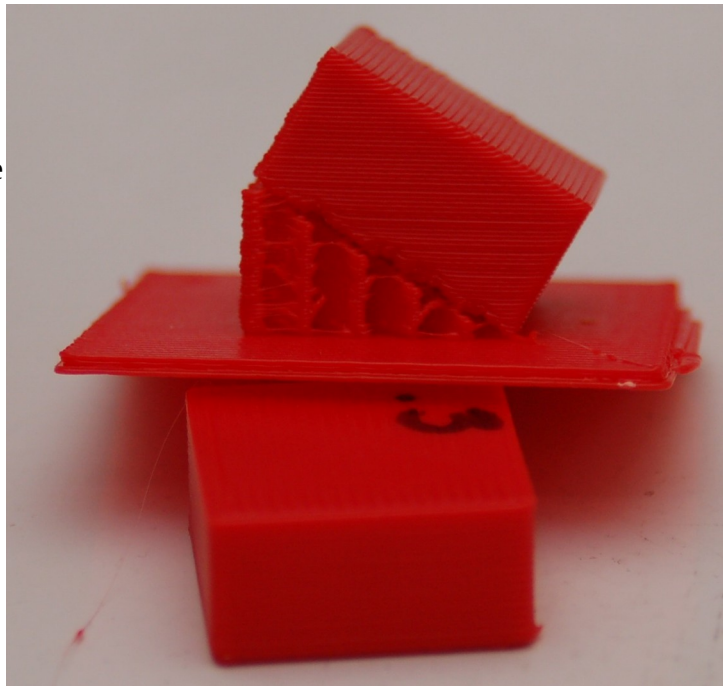

Fig. 5.1-6: Support & Raft.

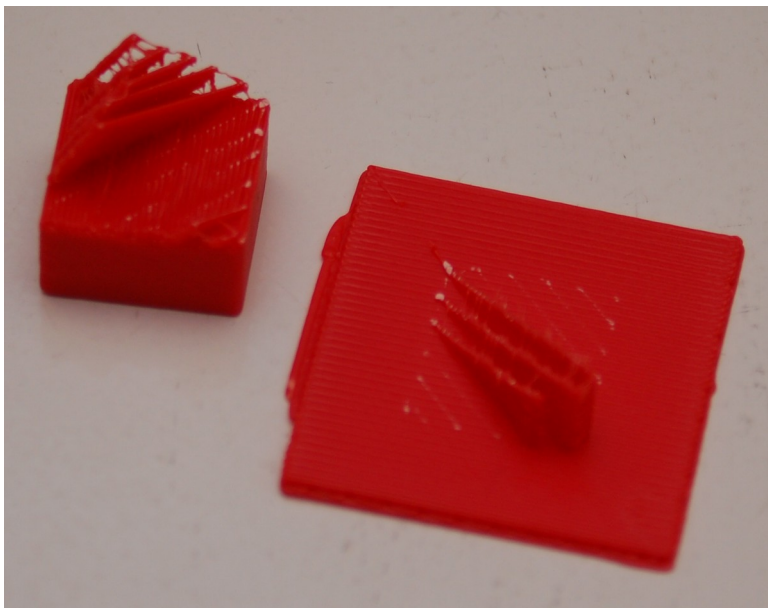

Fig. 5.1-7: Part separated from the raft.

The printed part will usually separate from the support material fairly easily – however, some material will be left behind if you're using a raft. Cleaning up the left over support material is a simple and straightforward task.

Here's what you end up with after removing the support material from your part. As you can see, there's still a little clean up to be done to the printed cube (on the left). A quick hit with some 220 grit sandpaper will knock the rough edges of the support material down.

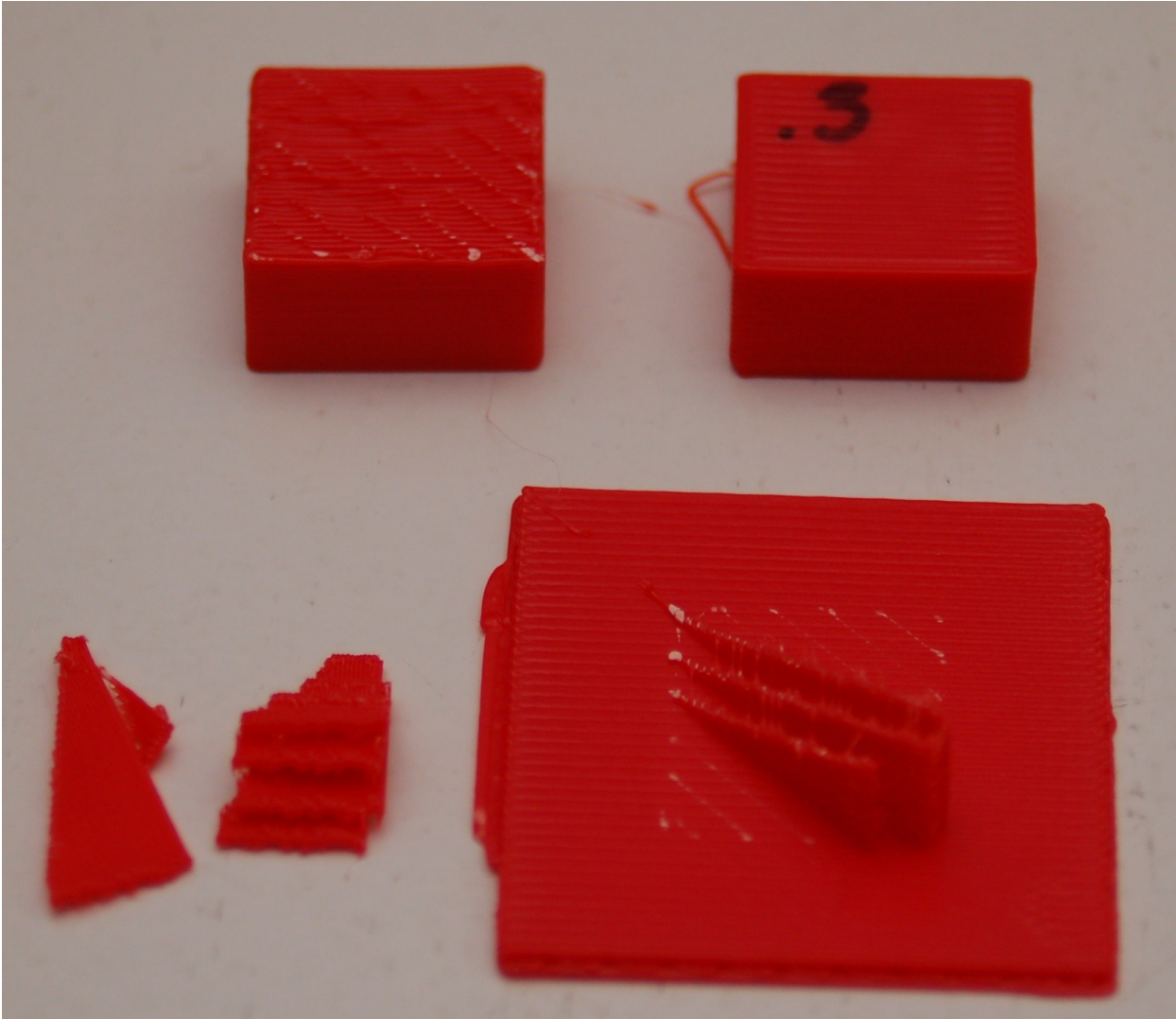

Fig. 5.1-8: Part cleanup.

That's pretty much all there is to the **Simple** settings level. Next, let's dig into the **Intermediate** setting!

Click on the **Simple** setting drop down and pick **Standard**. Your MatterControl settings screen should change to something resembling the image below.

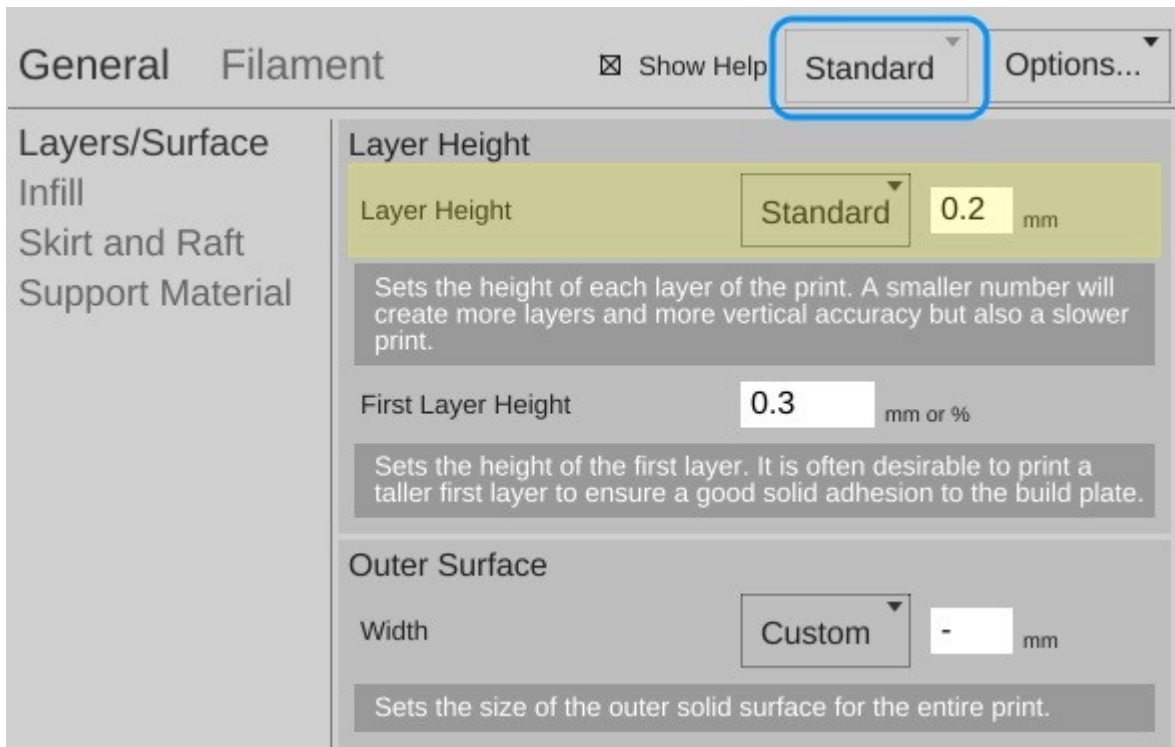

Fig. 5.1-9: Intermediate Settings.

Quite a number of new configuration options are accessible under the **Standard** settings level. The first set of options we'll tackle live under the **Print** heading.

Layers/Surface – This setting page allows you tweak the layer height just as before when in **Basic** mode, but now adds the **First Layer Height** and **Outer Surface** settings.

The **First Layer Height** setting allows you to specify how thick you want the first layer of the print to be. Bed adhesion depends on a good first layer!

The **Outer Surface** setting is often called “shells” because it controls how thick the “skin” of your printed object is going to be. The Standard setting will set the outer surface thickness to 0.6mm. I would recommend you choose the Full setting. This will give you a wall thickness of 1mm. Note that you can also specify how thick you want the wall by choosing the Custom setting and then enter the value (in mm) that you want the wall thickness to be.

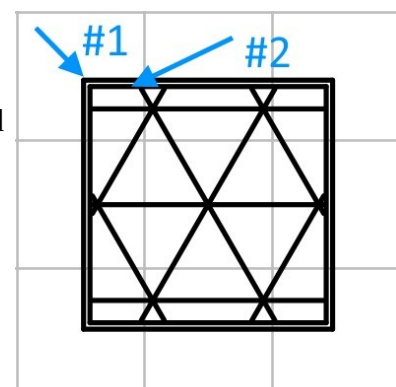

Fig. 5.1-10: Perimeters in Layer View.

In Fig. 5.1-10 is an example of what the Standard setting looks like. When the cube is being printed, the #2 perimeter is printed first and then the #1 perimeter. (The order is configurable.)

On the right, you can see what those perimeters actually look like on the cube we printed earlier.

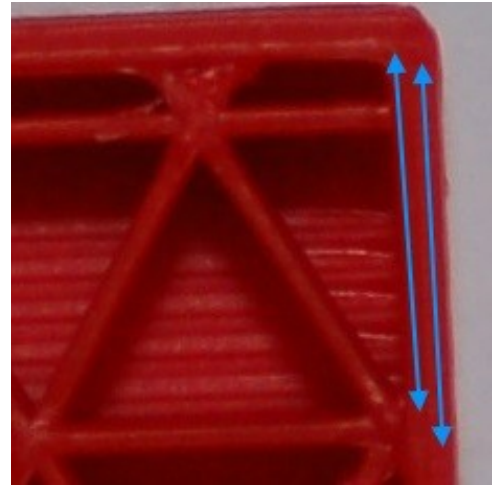

Fig. 5.1-11: Perimeters as printed.

Infill - The **Standard** level adds **Infill Type** in addition to the **Fill Density** figure we covered before. The infill types available are **Grid**, **Triangles**, **Hexagon**, **Lines**, and **Concentric**. Examples are shown below.



Grid



Triangles



Hexagon

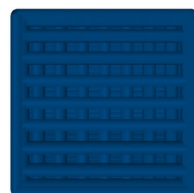

Lines

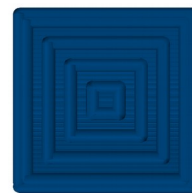

Concentric

The **Lines** infill pattern differ from the others in that the line orientation is alternated every other layer. All the examples show a 20% infill density.

You're probably wondering which infill pattern is “best”. I wish I could go into that, but I've been unable to locate any studies that cover the topic in any depth. If I were asked to provide a recommendation for a good structural pattern I would probably pick the **Triangles** option. It offers a good internal structure for most infill densities that I've used it with.

Skirt and Raft – This is a new option that appears with the **Standard** and **Advanced** setting levels. The **Skirt** option is used one of two ways. First, it can be used to “prime” the hot end with filament before the actual part itself begins to print. You may notice that your hot end may “drool” filament while the bed is heating up and the hot end has already reached temperature. This is perfectly normal. However, without some kind of priming action, early features of your part may not print properly. The **Skirt** solves this.

Secondly, the **Skirt** can become a **Brim** if the **Distance from Object** setting is set to zero. What this does is make sure that the skirt is physically connects to the part, becoming a brim. This can be handy when you're printing a small part and you're having bed adhesion issues and you don't want to have to use a raft. Later on in the **Advanced** settings section, you'll see more options on how you can tweak the **Skirt and Raft** settings.

Support Material – With the **Standard** and **Advanced** setting levels, you get more control over how the support material for your part is generated.

The new option here is called **Support Type** and allows you to choose a **LINES** or **GRID** pattern for the support material. When I printed the support example, I used the **LINES** mode as that is the default for the **Basic** settings mode. Looking down on it from above, this is what the **LINES** support material pattern looked like for that print.

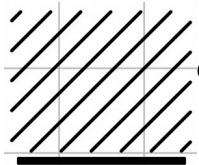

This shows the second layer of the print. The lines will continue to stack upon one another for the entirety of the support structure.

The **GRID** pattern (below) uses the same spacing as the **LINES** option, but is designed to provide more support where it may help to provide a better end result.

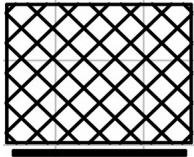

The next new category exposed by the **Standard** setting is called **Filament**. It provides **Filament** and **Cooling** categories. The **Filament** category includes the following options:

Diameter – This is the diameter of the filament you're using. The more accurate this figure is, the better the quality of your prints. This is because the slicer uses the filament diameter to help calculate the optimum flow rate for the extruder during the print.

In order to get an accurate filament diameter, spool off a meter or so of filament and check it in 10 spots along the length of the material. Record the measurements using a digital micrometer and average the results. That average should go into the **Diameter** field.

Extruder Temperature – This figure determines the target temperature of the hot end for the material you're printing with. A typical heat range for ABS is 220 to 240C and 190 to 220C for PLA. Other materials will have their own recommended temperature ranges. **NEVER, EVER, EXCEED 245C WITH THE STOCK HOT END!**

The reason for this is because of how the stock hot end is designed. It uses a PEEK section (a high-temperature plastic) as the “cold end” of the hot end. This material will begin to fail at 247C. If you need to print with a high-temperature filament such as Nylon, it's highly recommended that you purchase an all-metal hot end.

Extruder Wipe Temperature – This setting determines what temperature the hot end should be before performing a “wipe” operation. Leave this setting at its default of 0.

Bed Temperature – Like the **Extruder Temperature** the bed temperature is material-dependent. For ABS, a typical heated bed temperature range is between 80 and 100C. For PLA the range is typically 55 to 65C.

Bed Remove Part Temperature – This is the temperature the bed should be before removing the part from the heated bed. Leave this setting at its default of zero.

Retraction – Length on Move – This sets the distance the extruder should “retract” the filament out of the hot end. This is used when the nozzle is moving from place to place, but not printing. Retracts are used to prevent the nozzle from “drooling” on the print while it's rapidly traveling from one position to the next during a print job.

Retraction – Speed - This sets how fast the extruder motor retracts the filament out of the print head.

Retraction – Z Lift – This setting will cause the nozzle to lift a small amount before performing a non-printing move.

Retraction – Wipe Before Retract – This will cause the printer to try to wipe the nozzle before it performs a rapid move.

The **Cooling** category will allow you to specify the minimum and maximum fan speed that will be used if you've got cooling enabled.

Each filament can have different heating requirements, even within the same type and color! For example, it's not unusual to have two rolls of identical material require different hot end settings. Bed temperatures tend to be less variable.

When you're working with a new roll of filament, I recommend printing a test object or two in order to find out what the best temperature setting works best with that material. Note the settings on the spool label, or add your own. This presents a nice opportunity to explain another feature of MatterControl – material profiles! You'll notice a little pencil icon next to the material drop down

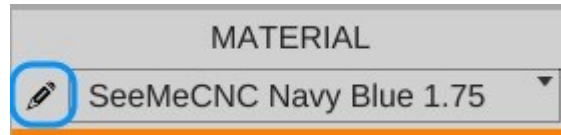

Fig. 5.1-12: Material Editor.

Click on that to bring up the preset manager.

The **Material Presets** list shows you what pre-configured material settings you've got available to you. When you get a new roll of filament in, you can easily keep track of its settings by using this system. Click on the **Add** button and we'll create your first custom material!

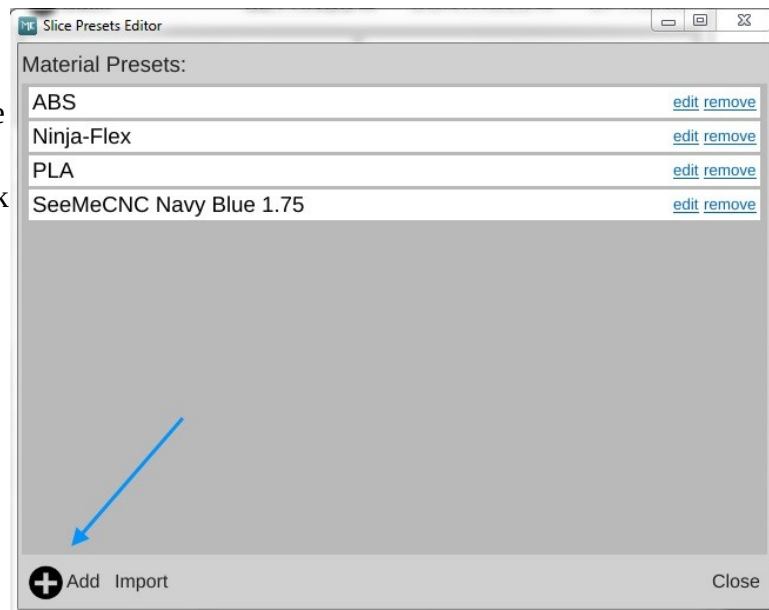

Fig. 5.1-13: Adding a new material preset.

Rostock MAX v2 User's Guide

When you click on the **Add** button, you'll be presented with a screen that looks something like the one shown on the below. The **Edit Preset:** field is where you can name this new material configuration.

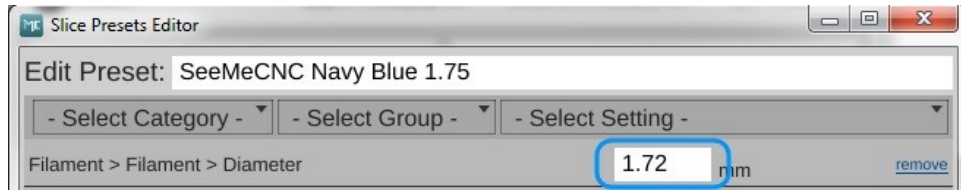

Fig. 5.1-14: Setting up a new material.

In this example, I've named it after the vendor and the material color. Since this is the first time I've used this material, the only thing I know for sure is what the average filament diameter is. To enter that, I picked **Filament** from the **Select Category** drop down, then from the **Select Group** drop down, **Filament** was chosen again and finally **Diameter** was selected from the **Select Setting** drop down.

I then entered the filament diameter that I calculated using the process I outlined to you earlier.

Click on the **Save** button to commit your changes. Congrats, you've added your first custom material profile!

After you've saved your new profile, it will appear as the currently selected material as shown to the right.

Now say you've printed a test cube and have decided that the print might look better if you bumped up the temperature 2 degrees. This is a simple change to make.

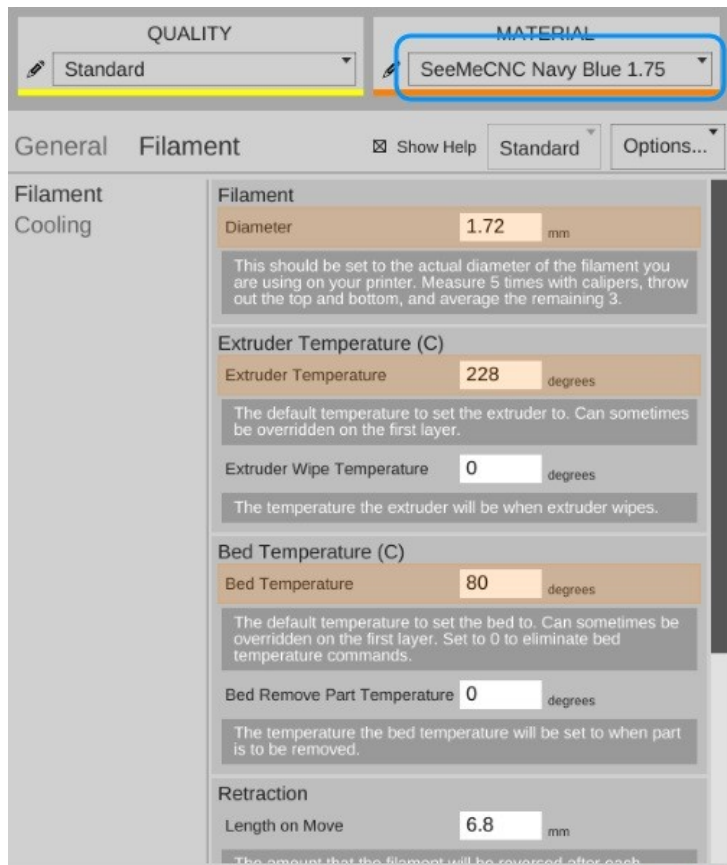

Fig. 5.1-15: New material added!

If you hover your mouse over the **Extruder Temperature** option, you'll see that the foreground is covered by an **EDIT PRESET** button as shown below.



Fig. 5.1-16: Overriding a preset value.

Clicking on the button will open up the materials editor and allow you to change the temperature. It's as simple as that!

We've covered both the **Basic** and **Standard** settings for the slicing engine. **Advanced** is something I'll cover later, so let's move on to the **CONTROLS** section.

The **CONTROLS** page is where you can manually control your Rostock MAX 3D printer. You can heat the hot end or bed, as well as manually position the effector platform and extrude plastic.



Fig. 5.1-17: Temperature control pane.

The **Temperature** pane contains everything you need to manually control the temperatures for both the hot end and the heated bed. MatterControl provides PLA and ABS presets. You can edit them by clicking the pencil icons. You can also enter in a temperature and heat to that value by clicking on the **SET** button that will appear as soon as you begin typing.

The **Movement Controls** pane contains controls that will allow you to manually position the Rostock MAX's effector platform.

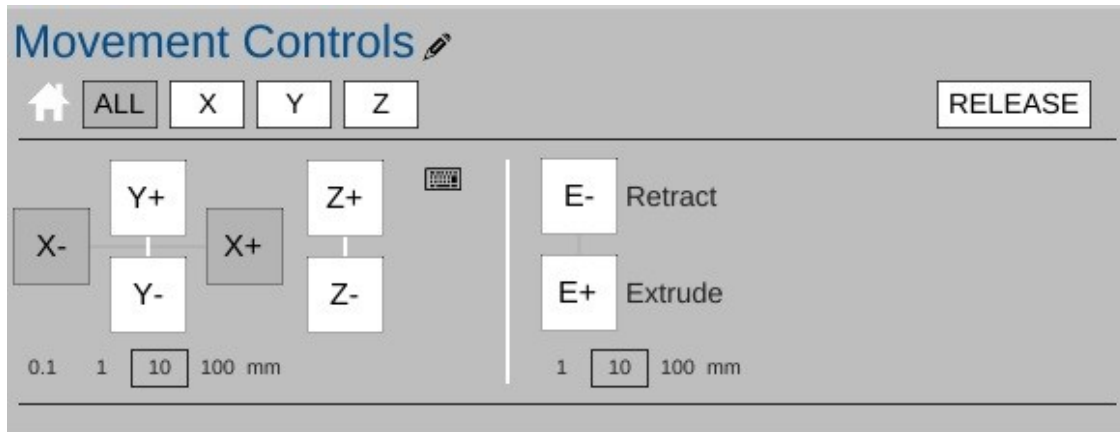

Fig. 5.1-18: Movement controls pane.

The row of buttons to the right of the little house icon control “homing” of the movement axes in the Rostock MAX. Because the Rostock MAX is a delta configuration printer, the only buttons active are the **ALL** and **Z** buttons – they perform the same action. Connect your printer if you haven't already and click on one of them to see what I mean. The printer will home itself and await further instructions. (Good robot! Have a Scooby Snack!) The **RELEASE** button will tell the Rostock MAX to power down the stepper motors so that the axes can be moved by hand. This is handy when you want to load new filament into the printer without having to turn it off first.

The axis motion is controlled by the X, Y and Z labeled + and – buttons shown above. Below those four buttons are selectors indicating the step distance from 0.1mm to 100mm. The selected axis will move the selected step distance with each mouse click. For this reason, please take special care when you've got 100mm set for the step distance. The Rostock MAX is smart, but not THAT smart. It relies upon you to not put the poor thing in an unlikely position. :)

The last set of buttons control the extruder motor – they're marked **E-** and **E+** and can be used to manually extrude filament. Note that they will only work if the hot end is up to operating temperature! The amount of filament extruded (or retracted) is set using the step selector below the control buttons for the extruder.

The **Fan Controls** allow you to manually control the layer fan on your Rostock MAX. The fan control will not control the PEEK fan as that is required to be on for the duration of the print job. You can turn the fan on 100% by clicking the control, your you can enter in a percentage value to set it to a speed lower than full-on. I'll go over the use of the layer fan when the **Advanced** settings are covered.



Fig. 5.1-19: Fan Control.

6 – MatterControl Basics: Loading and Printing Objects

We've previously worked with the small cube that MatterControl provided as an example. Now we're going to cover loading and slicing an object from start to finish.

For this section, I recommend you head over to <http://www.repables.com> and find something you'd like to print. I'm going to chose the Orion Key Chain (<http://www.repables.com/r/151/>) for my example print. You don't have to make the same choice, but pick something geometrically “simple” in order to make the learning process a bit easier.

Most (if not all) 3D printer slicing programs can read a file format called “STL”. (You can learn more about this file format, including its origins, here: [http://en.wikipedia.org/wiki/STL_\(file_format\)](http://en.wikipedia.org/wiki/STL_(file_format))) When you download a file from Repables or one of the other free, online object repositories, you'll often get the file as a zip file. One nice feature of MatterControl is the ability to select a zip file and MatterControl will transparently extract all the files it knows how to read and load them up into your print queue.

To load a file into MatterControl, make sure you're on the **Print Queue** page and click the **Add** button at the bottom right hand corner of the window.

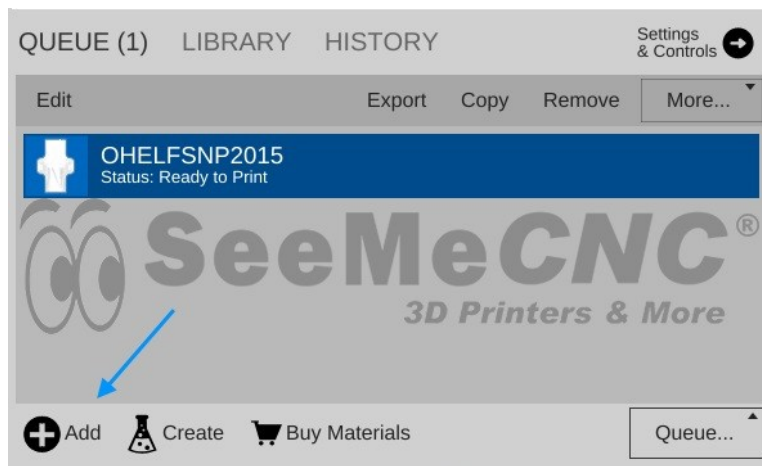

Fig. 6.1-1: Adding an object to the print queue.

Navigate to where you've stored the STL or ZIP file and open it using the Open File dialog that will appear.

Once you have the object loaded, click on the **Settings & Controls** button so we can make sure your print settings are the way you want them.

For my print, I've decided to leave the **QUALITY** setting at **Coarse** and I'm using the tweaked material values that I set up earlier.

Because the key chain is pretty large, I'm going to scale it down to 75% of it's original size. This is an easy task in MatterControl.

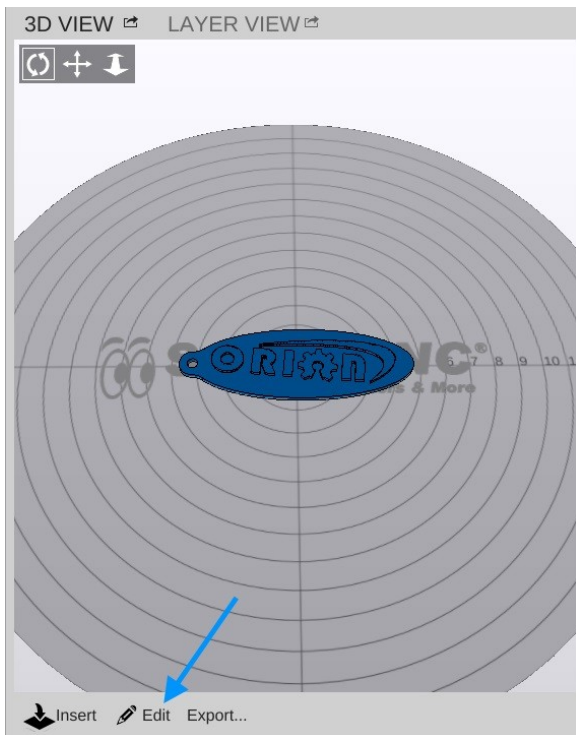

Fig. 6.1-2: Editing an object.

Click on the **Edit** button as shown above. This will modify the 3D View so the edit controls are visible.

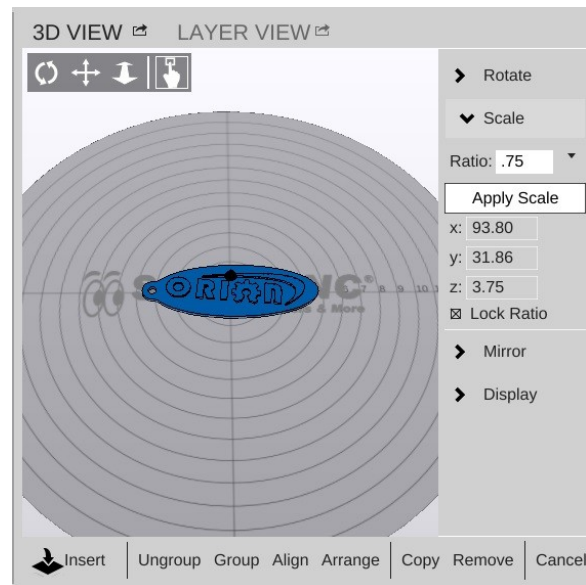

Fig. 6.1-3: Scaling an object.

Click on the **Scale** button to access the scaling controls. As you can see, I changed the value to 0.75 or 75% of its original size by entering the value and clicking on the **Apply Scale** button. Click on the small up arrow next to the **Save** button at the bottom of the window. This will allow you to save the object under a different name if you don't want to over-write the original.



Save-As.

The Save-As dialog presents you with three different locations you can save your changed model. “**Local Library**” points to the local library where MatterControl will store data on your local computer. “**Cloud Library**” points to your cloud storage at MatterControl HQ. You’ll need to create a free account with MatterControl in order to use this option.

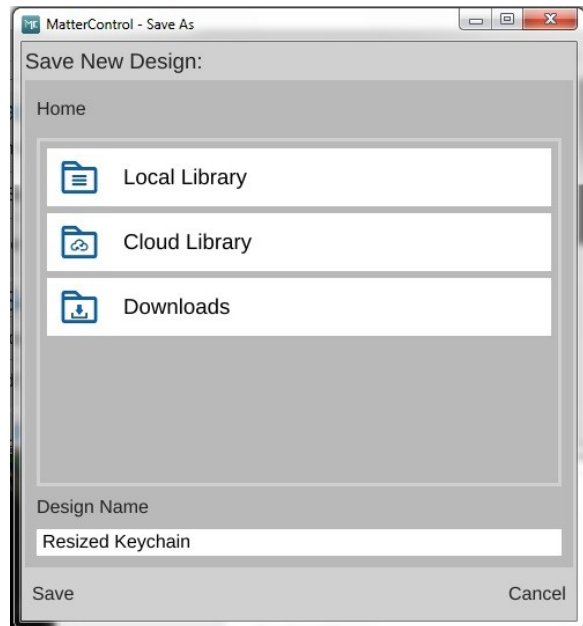

Fig. 6.1-4: Saving the scaled object.

Rostock MAX v2 User's Guide

Before we start this print, let's take a second to examine a feature of MatterControl – the **Layer View**. If you've not sliced this object yet, you'll likely see the text “Press 'generate' to view layers”. Go ahead and do that now.

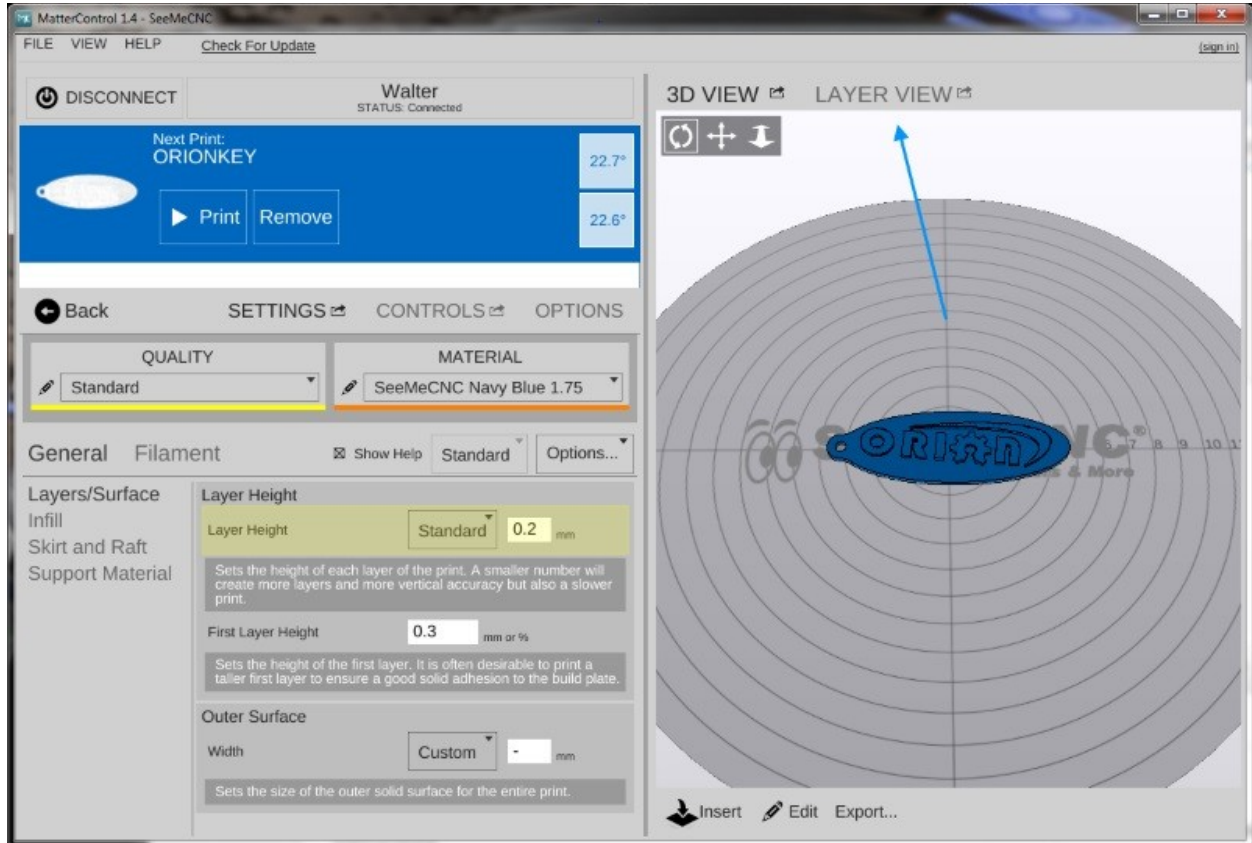

Fig. 6.1-5: The Layer View.

Rostock MAX v2 User's Guide

When it finishes, the layer view will display the first layer of your print job.

You'll notice right off the skirt that I covered previously. It's important to make sure that the hot end is primed by the time it begins to print your part!

At the bottom of the window you'll see some controls that will allow you to either re-slice the object (**Generate**) or view the individual print layers.

Generate << 1 / 18 >>

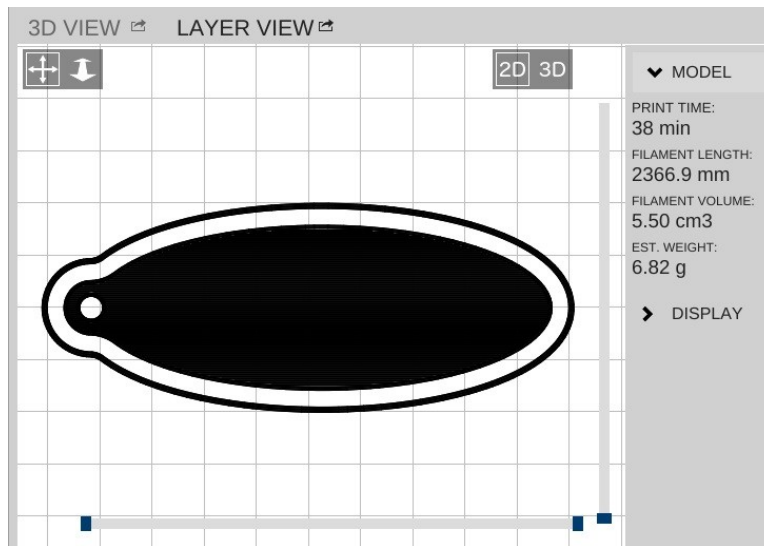

Fig. 6.1-6: First Layer.



Fig. 6.1-7: Model Stats.

The controls will show you how many layers are on this object as well as what the layer number is that you're currently viewing. You can navigate forward and backward through the layers by using the >> and << buttons. If you want to jump to a specific layer, you can enter it in to the box and click **Go**.

After slicing the object, MatterControl will display a few statistics about the current print in the Layer View window. This can be handy information if you're selling your services and need to know how much a particular part is going to consume in both time and materials.

Go ahead and click the **Print** button and get your object printing!

After the print finishes, you should have a little part that looks something like the photo below (if that's what you printed).



Fig. 6.1-8: Finished print!

7 – Advanced MatterControl: Configuration

MatterControl includes a number of basic configuration options that you can use to set up things like your default slicing engine, change EEPROM settings, etc.

Let's go over each one as they appear on the MatterControl Configuration pane.



Fig. 7.1-1: Automatic Print Leveling.

MatterControl includes a bed leveling feature that when properly configured, can assist with issues that can arise from an un-level bed. Note that this will NOT calibrate a delta printer! What it can do is help improve first layer performance on an already calibrated printer.

SeeMeCNC has put together a nice video that illustrates the process quite effectively:

<https://www.youtube.com/watch?v=z6ymbr-AMew>



Fig. 7.1-2: EEPROM Settings.

The EEPROM Settings configuration option will allow you to edit firmware parameters that are stored on the controller inside your Rostock MAX. Please take special care when changing EEPROM values. An improperly set configuration parameter can cause your Rostock MAX to misbehave. Sometimes rather dramatically. :)

Here's an example of the things you can change under the EEPROM Settings configuration:

Description	Value
Baudrate	250000
Filament printed [m]	10.572
Printer active [s]	12509
Max. inactive time [ms,0=off]	1800000
Stop stepper after inactivity [ms,0=off]	0
Steps per mm	80
Max. feedrate [mm/s]	300
Homing feedrate [mm/s]	120
Max. jerk [mm/s]	35
X home pos [mm]	0

Buttons: Save To EEPROM, Cancel

Fig. 7.1-3: EEPROM Table Editor.



Fig. 7.1-4: Accessing the G-Code terminal.

The G-Code Terminal is where you can directly interact with the firmware on your Rostock MAX. When you first open the G-Code Terminal, you'll be presented with a window that looks similar to the one below:

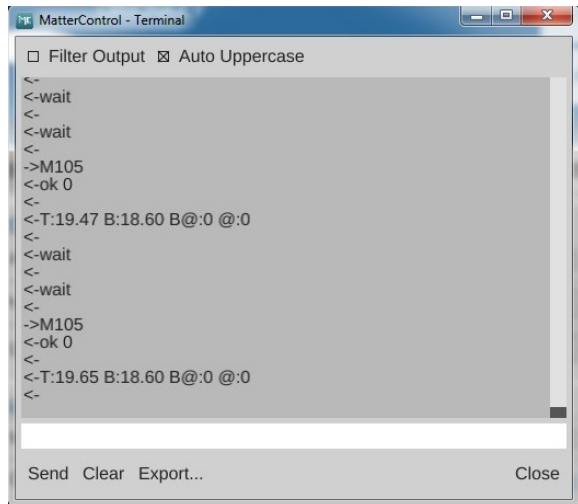

Fig. 7.1-5: G-Code terminal window.

You'll notice that the display will scroll as new information comes in from the Rostock MAX. This is how MatterControl is able to continually update things like the temperature displays. In order to be able to use the terminal for basic tasks, you'll need to click on the Filter Output check box that's at the upper left corner of the window. This will filter out the telemetry information coming from the Rostock MAX's controller and allow you to directly interact with the printer without having the output interleaved with the periodic information that the Rostock MAX transmits.

MatterControl provides the ability to remotely monitor your Rostock MAX printer from anywhere in the world. To learn more about this service, click on the **GO TO DASHBOARD** link in MatterControl.



Fig. 7.1-6: Cloud Settings.

By default, MatterControl will play a bell sound when the current active print job completes. However, you can change this behavior via the **Notification Settings** configuration screen.

You'll be able to configure MatterControl to send you an email or text message when your printer completes a job. Note that this feature is only available when you're using MatterControl to run a print job. If you're printing from the SD card, notification won't be possible.

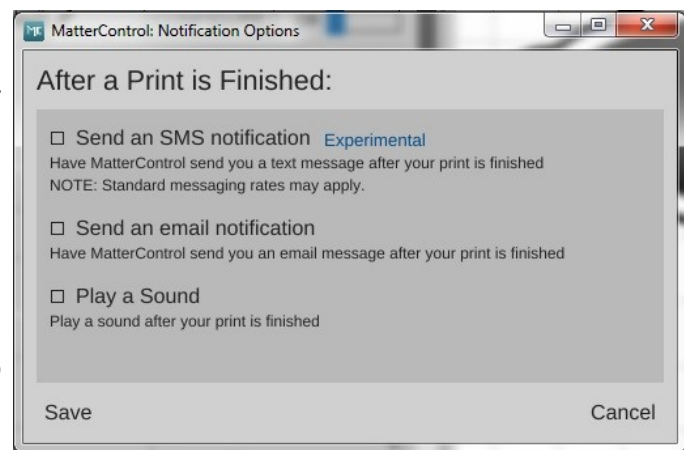

Fig. 7.1-7: Notification Options.

This particular configuration option should be pretty self-explanatory. I hope.



Fig. 7.1-8: Language Selection.

The **Slice Engine** configuration will allow you to choose which slicer that you want to use in order to prepare your model for printing. By default, MatterControl uses the **MatterSlice** slicing engine that was developed by the MatterControl team.



Fig. 7.1-9: Choosing a slicer.

You also have the option of choosing **Slic3r** or **CuraEngine** to do your slicing. Selecting a different slicing engine will change the options available on the **Settings** pane, but shouldn't disturb those you've changed in the past. The MatterControl team has tried to keep common names across slicing engines, so the most noticeable change you'll see will be additional options supported by one slicer but not the others.



Fig. 7.1-10: Thumbnail Rendering.

The Thumbnail Rendering option will change how the parts in the print queue are shown. The default “2D” thumbnail will look something like the example in Fig. 7.1-11. “3D” will appear as a slightly tilted model as shown in Fig. 7.1-12.



Fig. 7.1-11: 2D.



Fig. 7.1-12: 3D.

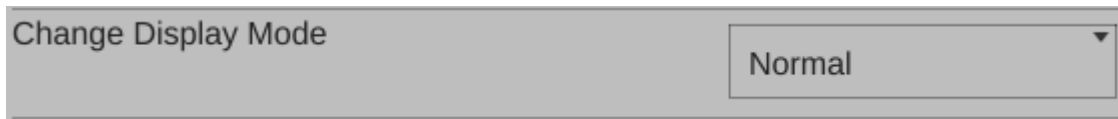

Fig. 7.1-13: Change Display Mode.

The Change Display Mode will allow you to switch between “Normal” and “Touchscreen”. The touchscreen interface is optimized for that type of input method. You'll need to restart MatterControl when changing the display mode.



Fig. 7.1-14: Clearing the print history.

Clear Print History will allow you to clear all the items from the **History** display.



Fig. 7.1-15: Display theme.

Theme/Display Options allows you to change the primary color that the user interface renders in. The top row of color selections provide the selected color against a light background. The second row of color selections provide the selected color against a dark background.

8 – Advanced MatterControl: Settings – General

MatterControl offers three “classes” of settings that have a direct effect on how your printer works. **General** covers elements that relate to how the plastic is laid down. **Filament** covers parameters specific to the type of filament that you've chosen to print with. **Printer** handles those remaining parameters that describe the physical printer you're currently using to print with.

Let's start this overview on the main page of **General, Layers/Surface**.

The screenshot displays the MatterControl software interface. At the top, there are two dropdown menus: 'QUALITY' set to 'Coarse' and 'MATERIAL' set to 'ABS'. Below these is a navigation bar with tabs for 'General', 'Filament', and 'Printer', along with a 'Show Help' checkbox, an 'Advanced' dropdown, and an 'Options...' dropdown. The 'General' tab is selected, and the 'Layers/Surface' section is expanded in the left sidebar. The main content area shows the following settings:

- Layer Height:** A dropdown menu set to 'Coarse' and a text input field containing '0.3' with 'mm' to its right. Below this is a description: "Sets the height of each layer of the print. A smaller number will create more layers and more vertical accuracy but also a slower print."
- First Layer Height:** A text input field containing '0.3' with 'mm or %' to its right. Below this is a description: "Sets the height of the first layer. It is often desirable to print a taller first layer to ensure a good solid adhesion to the build plate."
- Bottom Clip:** A text input field containing '0' with 'mm' to its right. Below this is a description: "The amount to remove from the bottom of the model"
- Outer Surface - Perimeters:** A text input field containing '2' with 'count or mm' to its right. Below this is a description: "The number, or total width, of external shells to create. Add mm to the end of the number to specify width."
- Avoid Crossing Perimeters:** A checkbox that is checked. Below this is a description: "Attempts to minimize the number of perimeter crossing. This can help with oozing or strings."

Print layers & perimeters.

The first parameter is **Layer Height**. We've covered this one before, but I wanted to point out something that I didn't go into a lot of detail about earlier. You'll notice that the field has a yellowish highlight to it. That means that the value exists in the currently selected **QUALITY** profile. If you look carefully, you'll see that the highlight color matches the thin colored line under the **QUALITY** drop down. (This same effect holds true for **MATERIAL** profiles, but the color is orange.)

Any time you add a **Print** parameter to a preset profile, it will be highlighted just as the **Layer Height** field is in the example. Note that you can use any of the **Print, Filament, or Printer** configuration parameters within either of the **QUALITY** or **MATERIAL** profile editors.

A dark grey rectangular field with the text "First Layer Height" on the left, a white input box containing "0.3" in the center, and "mm or %" on the right.

First Layer Height.

The **First Layer Height** parameter allows you to set the thickness of your first layer. Having a thicker first layer will help provide a good base to build the rest of the part on as the thicker (and thus wider extrusion) will help improve the adhesion to the bed. If your first layer isn't any good, the part could eventually separate from the bed and ruin the print job.

A dark grey rectangular field with the text "Bottom Clip" on the left, a white input box containing "0" in the center, and "mm" on the right.

Bottom Clip.

Bottom Clip allows you to tell the slicing engine that you'd like to "clip off" a specific amount from the bottom of the model. For example, say you've got a 200mm tall model, but you only want to print the top 50mm or so. You can enter 150 into the **Bottom Clip** field and when the slicer generates the G-Code for the print job, it will begin slicing 150mm up from the bottom of the model.

A dark grey rectangular field with the text "Perimeters" on the left, a white input box containing "2" in the center, and "count or mm" on the right.

Perimeters.

Perimeters dictate how thick the "skin" of your model is. 2 or 3 perimeters are good for most parts, but if you want a really strong exterior wall, you can make the perimeter count as high as you feel you need it. To get an idea of how thick the skin will be, you multiply the perimeter count by the extrusion thickness (we'll get to that parameter in a bit). For example, if you have a 0.5mm nozzle, chances are your extrusion thickness will be set to 0.5. 2 perimeters will give you a skin thickness of 1mm. You also have the option of specifying the perimeter thickness in millimeters instead of perimeter counts.

Avoid Crossing Perimeters

Avoid Crossing Perimeters.

When **Avoid Crossing Perimeters** is enabled, the nozzle path will not cross a part perimeter during travel moves. This will help reduce the opportunity for stringing or oozing since the nozzle tip is rarely over open air. For instance, if the tool path would normally cause the nozzle to travel from one side of the part to the other, it would cross at least two perimeters and may leave strings of material in its wake as it moves. If it is set to not cross perimeters, it will cause the nozzle to trace a perimeter back to the nearest point where it can begin printing again instead of jumping straight across to the new extrusion position.

Spiral Vase

Spiral Vase.

Spiral Vase mode allows you to print things like vases or other open top, single-wall objects in one continuous layer. What happens is that instead of the slicer raising the nozzle up a full layer height for each new layer, it gradually increases the Z height as the print progresses. This results in a perfectly seamless object, which can be important for artistic prints such as vases. When you're printing a vase or similar object, you'll want to make sure that you set the top layer count to zero to prevent the vase getting a "lid" that you'll have to cut off.

External Perimeters First

External Perimeters First.

By default, objects are printed from the inside features to the outside. If you want to reverse this process, enable **External Perimeters First**. This will cause the outside of the model to be printed before the interior features.

Top Solid Layers: count or mm

Bottom Solid Layers: count or mm

Top & Bottom solid layers.

The **Top** and **Bottom** solid layer parameters dictate how thick the top and bottom surfaces of your object are when printed. These two parameters fulfill essentially the same function as the **Perimeters** parameter, but for the top and bottom of the part. You can calculate your top & bottom thickness by multiplying the solid layer count by the layer height. For example, 5 top layers will result in a final top thickness of 1mm if your layer height is 0.2mm. You also have the option of specifying the top and bottom thickness in millimeters instead of layers.

The next page in **Print** is called **Infill** and covers how the interior of your part is filled. While I covered **Fill Density** and **Infill Type** earlier, the **Advanced** mode adds two new parameters.



Starting Angle.

The **Starting Angle** parameter allows you to control the orientation of the infill. For example, an infill type of **GRID** with a starting angle of zero degrees is going to look like this:

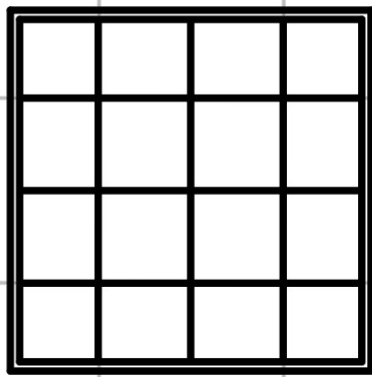

Grid infill.

Now if you change the starting angle to 45 degrees, you'll end up with an infill pattern that looks like the example below.

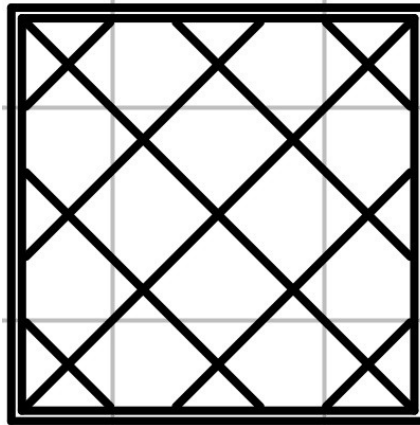

Grid @ 45 degrees.

Note that changing the starting angle will also change the angle in which the top and bottom layers are printed. You can see this in the image below – this shows the second layer as it would be printed.

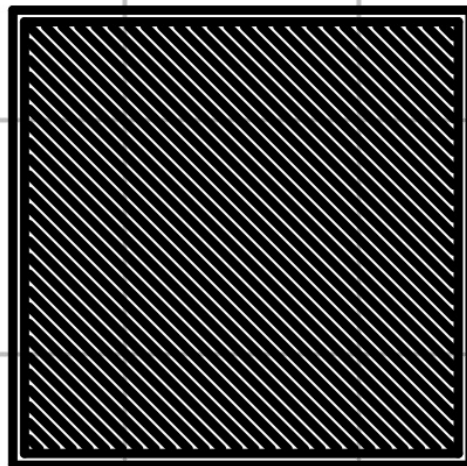

Top & bottom layer pattern.



Infill Overlap.

Infill Overlap is used to adjust how well the infill pattern attaches to the inside perimeter of the part. A good infill will have a solid connection to the inside perimeter of your part, and the structural integrity of your part depends on this.

The **Speed** page covers parameters that control how fast various features of the object are printed. The speeds are listed in mm per second, or as a percentage of a related speed parameter.

The speed parameters are pretty self-explanatory, especially if you've got the **Show Help** check box set. However, there's a couple of points I'd like to cover about printing speed.

First of all, there is a relation between your print speed and the temperature you've set for the material you're printing with. The basic rule is, the faster you go, the hotter you print. This is because as the hot end extrudes plastic, it's constantly being cooled by the cold filament that's coming in.

Setting the extrusion temperature higher allows the hot end to melt the incoming plastic at a faster rate. This allows you to print more quickly. The relation between print speed and extrusion temperature is one of those things you'll get a feel for as you gain experience with your printer.

You'll quickly learn that the Rostock MAX will “talk” to you if you're printing too rapidly for

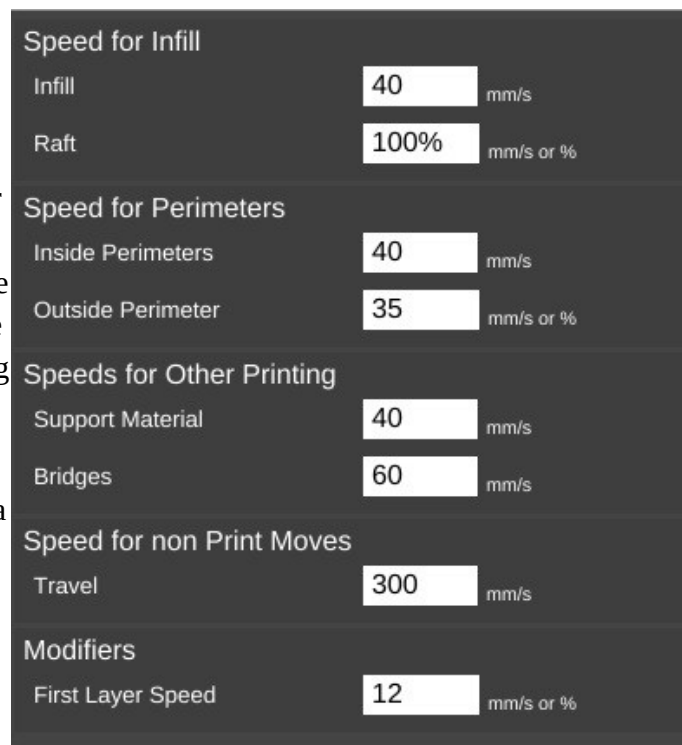

Print Speeds.

a given temperature. The extruder will begin to “skip” periodically (or frequently, depending on how fast you're going). A skipping extruder has a very distinct sound – it's kind of a light bump or knocking. If you watch the nylon gear that you use to manually feed filament, you'll notice that it will briefly rotate in the opposite direction at the same time you hear the skipping sound. If you draw a line on the face of the gear, you can spot this motion more easily. The skip is caused by the hot end's inability to melt the material as rapidly as is required. The pressure builds up until the stepper motor can no longer generate the force required. At this point the tension in the filament is released like a spring and the filament pushes back with enough force to cause the stepper motor to skip steps, resulting in a short reverse rotation.

Secondly, there is also a direct relation between print speed and print quality. In the image above, you'll notice that the speeds for print moves vary a bit. This is because some features don't require a focus on surface quality.

Perimeters are a great example of this. You'll note that the inside perimeter speed is 40mm/sec, while the outside perimeter is 35mm/sec. The inside perimeter will never be seen after the print is finished so it can be printed at a higher rate. However, you want the visible surface of the print to be smoother and more consistent, so you print the outside perimeters a bit more slowly.

The last bit about speed settings I want to cover is the first layer speed. You'll see that it's *really* slow. The reason for this is that while hot plastic loves to stick to hot plastic, hot plastic doesn't like sticking to other things as much. By going slowly on the first layer, you're giving the material time to get a good grip on the surface of the bed. This is known as “part adhesion”. When a part comes unstuck from the bed during a print, it's ruined. This isn't so bad when you're five minutes into a print, but you'll be ready to flip a table when it happens 18 hours into a 19 hour print.

The **Skirt and Raft** page covers settings that control how the hot end is primed at the beginning of a print job as well as features that help the part stick to the bed.

The first section covers the **Skirt** feature. A skirt in this context is basically a series of single-layer loops printed around the perimeter of the part. This acts as a method to “prime” the hot end with material before the actual part begins to print. **Loops** defines how many times you want to go around the print. This is tied to the **Minimum**

Extrusion Length parameter. If the number of loops you specify are not enough to meet that minimum length, additional loops will be added automatically.

The **Distance from Object** parameter dictates how far away the loop stands off from the part outline. If you set the distance to zero, the skirt will become a “brim”. It will result in the loops being printed connected to the first layer of your print. This can give small parts a first layer that has a larger surface area to improve part adhesion. Since the brim is only a single layer thick, it's usually pretty easy to remove after the print job has completed.

I mentioned earlier that hot plastic really loves sticking to hot plastic, but not so much to other things. If a brim isn't doing the job for you, you can try a **Raft**.

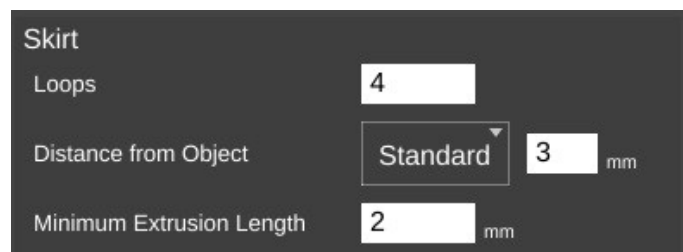

Skirt parameters.

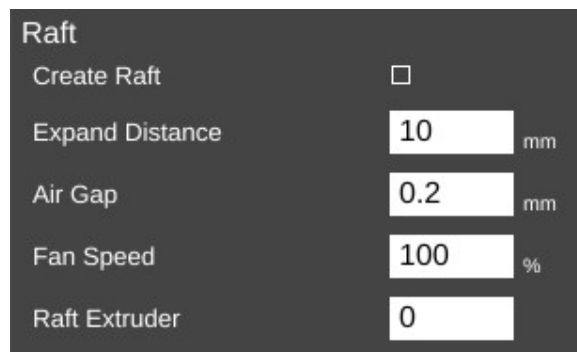

Raft parameters.

When in **Standard** mode, the **Raft** setting was simply an on/off setting. In **Advanced** mode, you've got a lot more control over how the raft is laid down.

Expand Distance is the distance you'd like the raft to exceed the base area of the part you're printing. You may want to adjust this parameter if the part you're printing is larger than the bottom contact point on the bed. A larger raft will help to support the part more effectively.

Air Gap defines how much space you want between the top surface of the raft and the bottom surface of your part. This gap helps make it easier (or even possible!) to remove the raft from your part when it's finished. As mentioned in the help text, a good air gap is one half the diameter of the nozzle. For example, if your nozzle is 0.5mm, you'd want an air gap of 0.25mm.

You can use the **Fan Speed** setting to cool the raft as it's being printed. This is typically only used when printing with PLA.

If you've added a second extruder to your Rostock MAX, you can specify which one should be used for rafts by setting the **Raft Extruder** value to the index of the extruder you want to use. If you don't have multiple extruders, you can leave this set to zero.

The **Support Material** page provides detailed settings on the use of support material if the part you're printing requires it. While I covered the basics of support earlier, I'm going to get a bit more in-depth on it here.

Checking **Generate Support Material** will allow you to configure support for your part. Support is required when a part has an overhang or other angled feature that would result in little or no physical support to put a print layer on. The **Support Type** selection allows you to define the geometric pattern for the support *Support Material*. structure. You have **GRID** and **LINES**.

These patterns were covered earlier, so I won't cover them again here. The new parameter you have to work with in **Advanced** mode is called **Amount**.

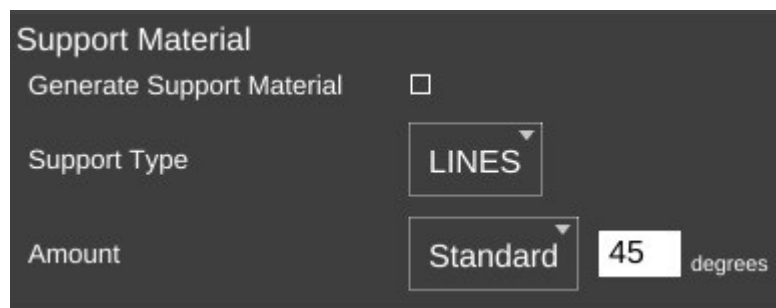

Amount is expressed in degrees from vertical and tells the slicing engine to generate support for any feature that meets or exceeds the specified angle. In the setting shown above, the slicing engine will generate support at points where the model “overhangs” 45 degrees or more from vertical.

When you've got a part feature that's only 20 degrees or so, each layer can easily be supported by the layer underneath. This is because as the part height increases, the horizontal dimension increase is less than the extrusion width. This means that each new layer has a solid foundation to adhere to as it's being applied.

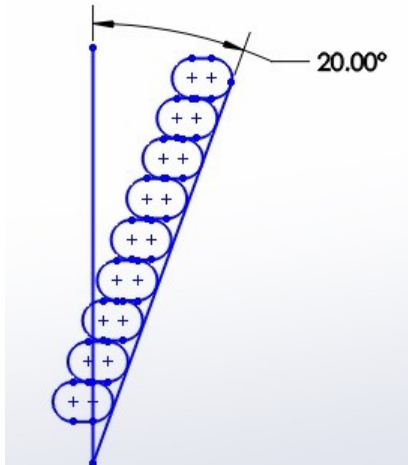

20 deg. overhang.

As you can see when your angle increases to 45 degrees, each layer has much less surface area to adhere to as you print. This is where support comes in handy. It provides that underlying structure for those layers to build upon.

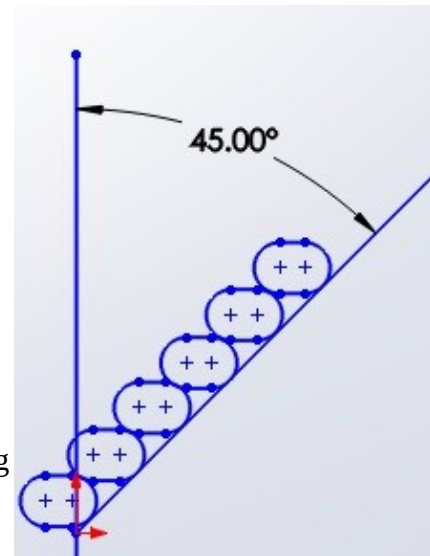

45 deg. overhang.

As the angle increases, the underlying surface area for each layer becomes smaller and smaller until there's simply not enough surface for the next layer to adhere to. In these instances, support material is practically a requirement if you want your part to print at all.

Now that you've got a good handle on why support can be useful, let's go over the parameters that you can tune to get good support that is easily removable from your part.

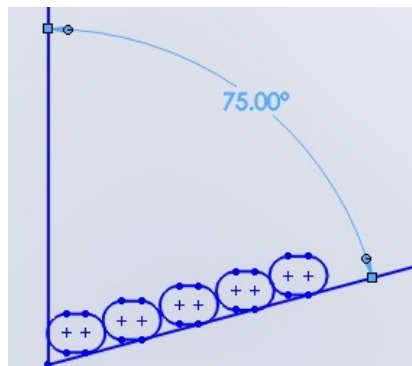

75 deg. overhang.

Pattern Spacing controls the distance between each “track” of support that is laid down to support your part. The wider the spacing, the less support that is printed.

Infill Angle adjusts the angle at which the support structure is built.

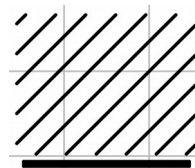

45 Deg. Infill

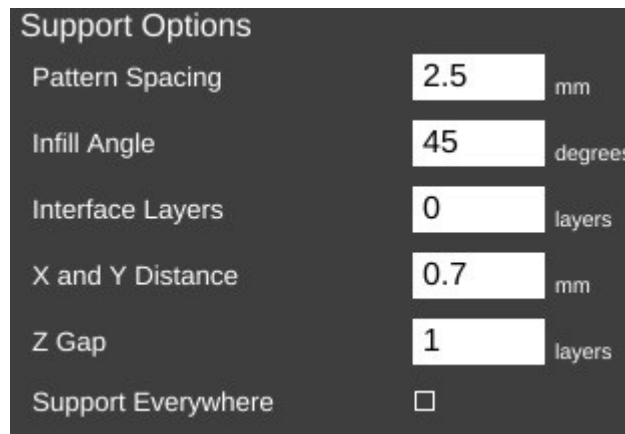

Support Options.

Interface Layers allows you to specify solid layers interspersed with the support material. This comes in handy when using multiple extruders. For example, if you're printing a part in PLA with lots of support, you can generate all the support with PLA, and then have 5 or 6 interface layers of PVA (a water soluble filament). The print would then only be in contact with the PVA interface layers and it would be a flat layer to print on. When finished you can dissolve away the interface layers and the rest of the support falls off the part cleanly.

X and Y Distance dictates how far away the support structure will be from the part you're printing. You want it as close as you can get it without it actually touching the surface of the part. The default of 0.7mm seems to work out pretty well.

Z Gap specifies how many layers should separate the support material from the part. This parameter contributes to how easy or difficult it is to remove support material from the part once the print is finished. If you have too little gap, the support material will have more of a grip on the part surface making it difficult to remove. If the gap is too large, the support material won't be able to do its job very effectively.

If **Support Everywhere** is checked, you're probably going to get more support material than you bargained for. If you have an internal feature of a part, this may be required in order to support it, but keep in mind that it will also add support to features like horizontally oriented holes, which don't normally need support to print properly.

If you've got multiple extruders on your Rostock MAX, these parameters allow you to specify which extruder is used for generating support structure.

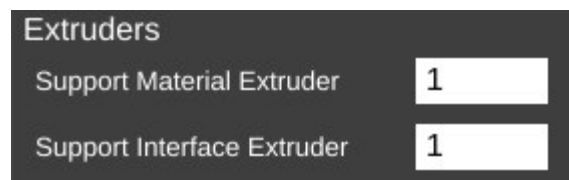

Extruder Settings.

The **Repair** page contains a couple of settings that govern how (and if) the slicer will attempt any repair of invalid part models.

Sometimes modeling programs will create a model that isn't "water tight", meaning it's got gaps in the surface. These gaps make it difficult for the slicing engine to do its job and in some cases can cause the slicing operation to fail. The **Repair** option is MatterSlice's attempt to help fix these issues if they're detected.

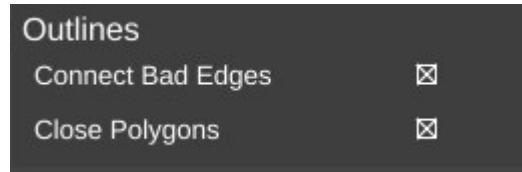

On the **Output Options** page is a single parameter, **Center On Bed**. This will automatically center the model on the print bed when you load it. If you don't want that to happen, just un-check the box.

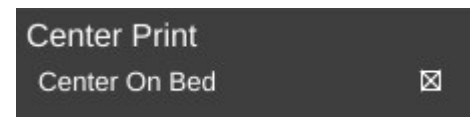

Center Bed.

The **Multiple Extruders** page has two settings that control how ooze & filament wipes are handled.



Wipe Shield.

The **Wipe Shield Distance** specifies how far away from the part you want what is commonly known as an "ooze shield" to be placed around the part. In a two extruder system, the unselected hot end will create this "shield" in order to avoid dripping or oozing plastic on other parts of the model.

Wipe Tower is used when changing extruders. The active nozzle creates a tower of the specified size and will use it to wipe the nozzle in order to reduce the possibility of oozing or dripping material on the model while the other extruder is active.



Wipe Tower Size.

9 – Advanced MatterControl: Settings – Filament

The **Filament** tab allows you to change parameters that deal with the current filament you're printing with. The **Filament** page is divided into three categories; **Filament**, **Temperature**, and **Retraction**.

The filament **Diameter** parameter tells the slicing engine the size of the material you're printing with. When starting a new roll of material, you should pull off about 2 meters of material and check it in 10 spots along the length using a digital caliper. Average those samples and plug the result into the **Diameter** field. This is a good way of getting a good estimate of the material you're actually using. This allows the slicing engine to deliver more consistent results instead of depending on the generic size of the material.

Filament	
Diameter	1.72 mm
Extrusion Multiplier	1

Setting the filament diameter.

You'll notice that the **Diameter** field is highlighted in orange. This means that the parameter is part of a predefined material configuration. When using a new spool of material for the first time, it's a good idea to create a new profile for it when you're taking the sample measurements of the diameter. A good rule of thumb is to include the date you started using the filament as part of the material profile name. Note the date on the spool label if it has one and add one if it doesn't. This will help you track individual spools of the same color and manufacturer.

The **Extrusion Multiplier** parameter allows you to tweak the flow rate of the material coming out of the hot end. A basic rule of thumb on this is to restrict the max value to 1.1 and the minimum value to 0.9. Note that these aren't hard limits but are simply a guideline to utilize until you're familiar with the effects this parameter has on print jobs.

The **Extruder Temperature** is the temperature for the hot end, **Extruder Wipe Temperature** is used to set the hot end temperature for wipe operations.

Bed Temperature is the temperature for the heated bed, **Bed Remove Part Temperature** is the temperature at which the part can be removed.

Note that neither the **Extruder Wipe Temperature**, nor the **Bed Remove Part Temperature** are applicable to the Rostock MAX v2.

Extruder Temperature (C)	
Extruder Temperature	228 degrees
Extruder Wipe Temperature	0 degrees
Bed Temperature (C)	
Bed Temperature	80 degrees
Bed Remove Part Temperature	0 degrees

Setting temperatures.

As you can see, both of these are part of the currently selected material profile. Each material class has a general temperature range for the hot end. For example, ABS extrusion temperatures can range from 195 to 240C. PLA likes anywhere from 180 to 215. The specific temperature that your material works best at varies by manufacturer and chemical blend. It's not unusual to see different “sweet spot” temperatures among identical colors of material, even with the same manufacturer.

The **Bed Temperature** parameter typically has a lot less of a range than the extrusion temperature does. A good rule of thumb here is 55-60C for PLA and 80-100C for ABS.

Retraction covers how the slicer “retracts” the filament during travel operations where it's not actually laying down plastic. Good retraction settings help keep your part free of little strings and blobs during printing.

Length on Move specifies how much filament will be backed out of the hot end during a non-printing move.

Length on Tool Change is specific to multi-extruder systems. If the slicer is changing to a new extruder, it will retract the material out of the current hot end by this much. This works in conjunction with wipe towers and wipe shields.

Speed dictates how fast the extruder drive will pull the filament out of the hot end. Higher speeds can assist in preventing already-melted plastic from oozing or leaving strings on the part being printed. It also controls how fast the filament will be returned to the hot end when the non-printing move has completed.

Z-Lift is used to lift the nozzle off of the part as each retract finishes. This can help prevent blobbing.

Extra Length on Restart is used to extrude some extra filament after resuming from a retract operation.

Minimum Travel Requiring Retraction is used to prevent retractions during very short moves when retraction isn't really necessary. When executing a non-printing move, the nozzle will have to travel at least this distance in order to trigger a retraction action.



Configuring retraction settings.

Minimum Extrusion Requiring Retraction specifies how much filament must be extruded before a retraction operation is permitted. This helps prevent instances where a retraction operation would occur before the hot end had the opportunity to actually extrude material.

Wipe Before Retract will wipe the nozzle before starting the retract process. This helps to eliminate stringing and oozing.

The **Extrusion** page has but two parameters.

First Layer allows you to specify the width of the first layer as it's laid down. Setting the value to greater than 100% can assist in first layer adhesion.

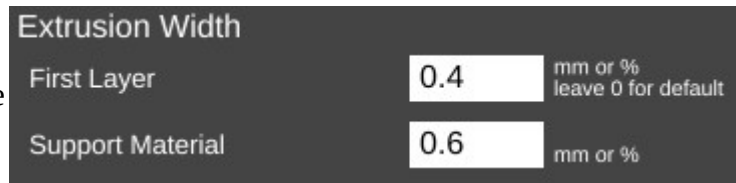

Extrusion width.

Support Material will allow you to tune the extrusion width used when printing support material.

The **Cooling** page covers parameters relating to layer cooling.

The **Fan Speed** section controls how and when the cooling layer fan is used.

Minimum and **Maximum Fan Speed** controls the lower and upper limits of how fast you want the fan to go when it's enabled. If you specify a minimum speed, the slicing engine will automatically vary the speed of the fan between the min & max values, depending on the location being printed. For larger parts, the slicing engine may run the fan more slowly than it would for smaller parts.

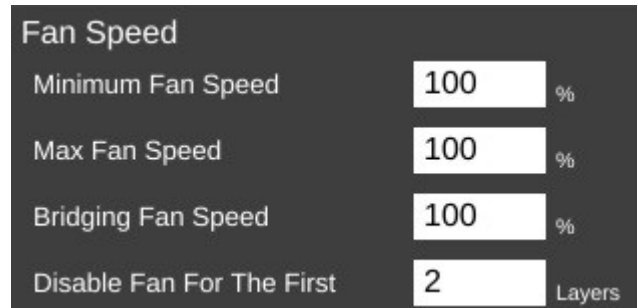

Setting cooling fan speeds.

Bridging Fan Speed covers the speed that the fan should run at when the slicer is creating a filament bridge. A bridge is basically a free-hanging length of filament with no support below it. Some materials like PLA form excellent bridges if cooled while being extruded.

Disable Fan For The First n Layers allows you to make sure that the fan isn't activated during the crucial first few layers of a print. You typically don't use the fan for at least the first two layers in order to help ensure good bed adhesion.

Cooling Thresholds allow you to slow the print speed down during a print if needed. If the current layer will require more than the specified time to print, the slicing engine will automatically slow the print speed down to meet this goal.

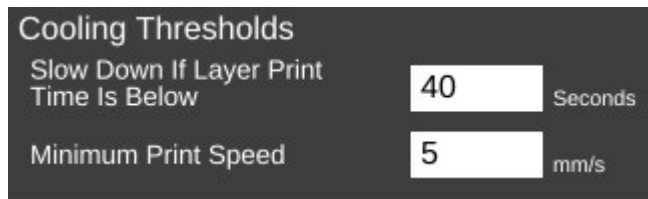

Setting cooling thresholds.

Rostock MAX v2 User's Guide

This can be important because if you don't use a fan, a layer will need time to radiate its excess heat before the next layer is applied. If the material isn't cooled, or given time to cool via radiation, heat can build up in the underlying layers and cause curling and other undesirable effects.

Minimum Print Speed can be used to ensure that the printer doesn't slow down TOO much, which can cause its own heating problems. For example, if you're printing too slowly, the presence of the nozzle moving over the surface can cause heating to areas adjacent to the nozzle tip which can cause blobbing or layer deformation.

Enable Extruder Lift if set, will cause the hot end to lift up from the part to allow cooling.

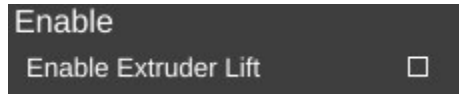

Enabling extruder lift.

Note that none of the fan options will come into effect unless you've enabled the operation of the fan. I'll cover that in the next section.

10 – Advanced MatterControl: Settings – Printer

The **Printer** section covers items that are specific to the printer being used for the current print job.

The **Print Area** page covers parameters that describe the mechanical features of the printer.

The **Bed Size** fields cover the width and length of the bed. Since the Rostock MAX has a round bed, you'll see that both figures are the same, the **Print Center** has been set to 0,0 (the center of the circle) and the **Bed Shape** has been set to **circular**.

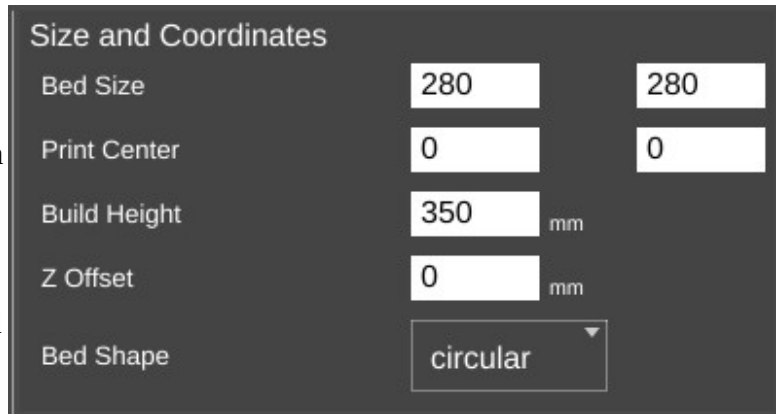

The Rostock MAX bed size should be set to 280/280. *Setting printer size and coordinates.*

The **Build Height** parameter should be set to the highest practical build height. In the case of the Rostock MAX, this is set to 350mm.

Z Offset can be used if you want to set a specific adjustment to the z position of the G-Code when it's created by the slicing engine.

The **Bed Shape** parameter dictates what bed type is shown in the 3D viewer.

The **Hardware** section allows you to specify what features are installed on your Rostock MAX v2.

Has Fan, when checked will allow the slicing engine to control the layer cooling fan.

Has Hardware Leveling should be set if you've added a mechanical depth probe for leveling the bed on your Rostock MAX.

Has Heated Bed should be checked for the Rostock MAX v2. This allows the slicing engine to control the heat of the bed.

Has SD Card Reader should be checked for the Rostock MAX v2. This allows MatterControl to save STL and G-Code directly to the SD card if it's installed in the Rostock MAX.

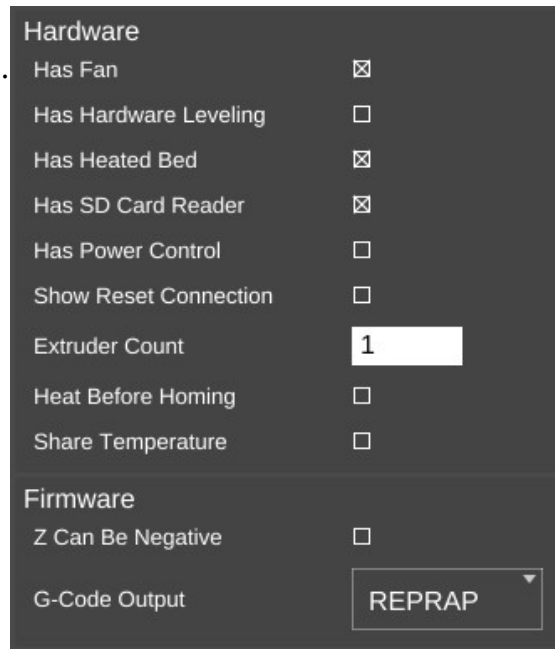

Basic hardware settings.

Has Power Control indicates whether or not your printer can control its own power supply. In the case of the Rostock MAX, this should be left unchecked.

Show Reset Connection This will enable a “reset” button that will reset the connection when pressed. It can be used as an emergency stop on printers that support it.

For a stock Rostock MAX, **Extruder Count** should be set to 1. If you add an additional extruder in the future, you can tell the slicing engine about it here.

Heat Before Homing When checked, this will cause the hot end to be heated before the printer is sent to its home position, instead of after.

Share Temperature is used when utilizing multiple extruders that share the same heat source.

The **Firmware** section allows you to tell the slicing engine about the firmware you're using with your Rostock MAX.

Z Can Be Negative can be checked if the firmware you're using on your Rostock MAX will accept Z positions below zero. Leave this unchecked if you're using the stock Rostock MAX firmware.

G-Code Output specifies what “flavor” of G-Code should be created by the slicing engine. For the Rostock MAX, this should be set to **REPRAP**.

The next page is called **Custom G-Code** and allows you to customize the code sent for five different print events. Unless you're familiar with what the listed G and M codes do, please don't modify the defaults shown.

Start G-Code is inserted into the G-Code output right after the temperature setting. If you have the commands to set the temperatures in this section, they won't be generated outside of this section. You can also include values from other sections such as “first_layer_temperature”

End G-Code is inserted into the output at the very end, after all print operations have been completed.

Pause G-Code is sent when the Rostock MAX is paused during a print.

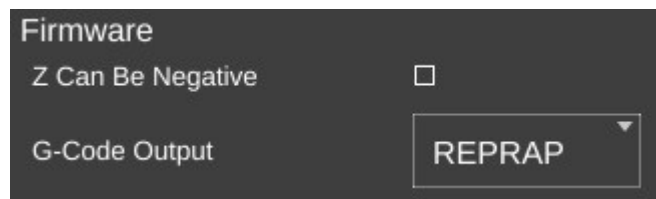

Firmware type.

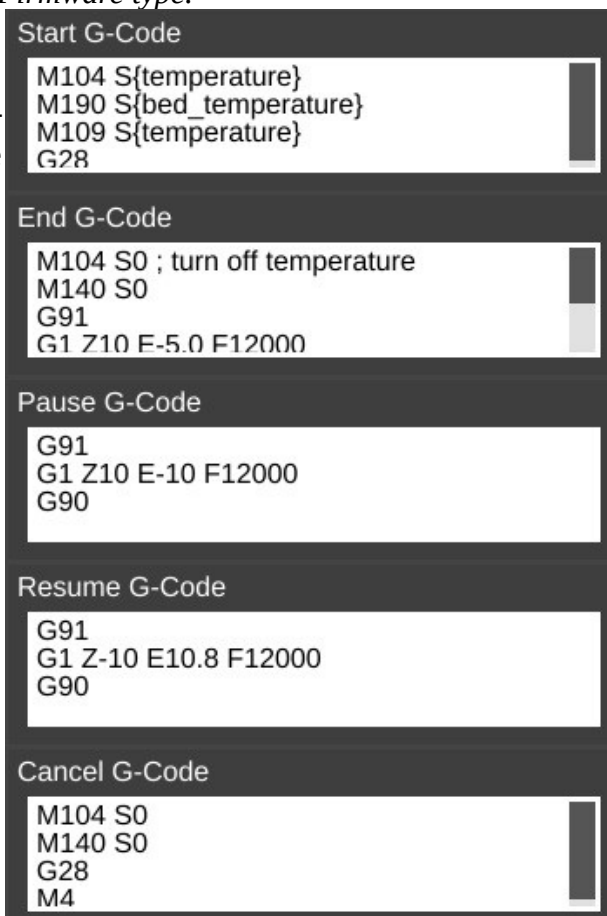

Custom G-Code settings.

Resume G-Code is sent when the Rostock MAX is resumed.

Cancel G-Code is sent when you cancel a print job from MatterControl

The last page for the **Printer** tab is called **Extruder**. This page allows you to configure each extruder you have installed in your Rostock MAX.

Nozzle Diameter specifies the diameter of the currently installed nozzle in the hot end.

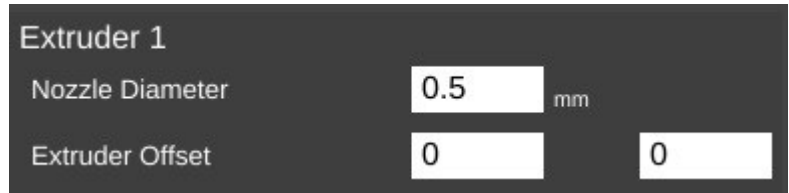

Extruder 1		
Nozzle Diameter	0.5	mm
Extruder Offset	0	0

Extruder settings.

Extruder Offset allows you to specify the offset from the center of the effector platform in the Rostock MAX. This parameter is only used in multi-extruder configurations.

The last feature I'd like to cover can be found here:

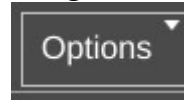

The **Options** control allows you to import and export configurations. This can be handy when you want to share your slicing engine settings with others, or import settings from other sources.

11 – Using the 3D and Layer Views

Using the 3D View and Layer View

The 3D View will show you the part that will be printed when you hit the **Print** button. The Layer View is used to inspect how your part will be printed, one layer at a time.

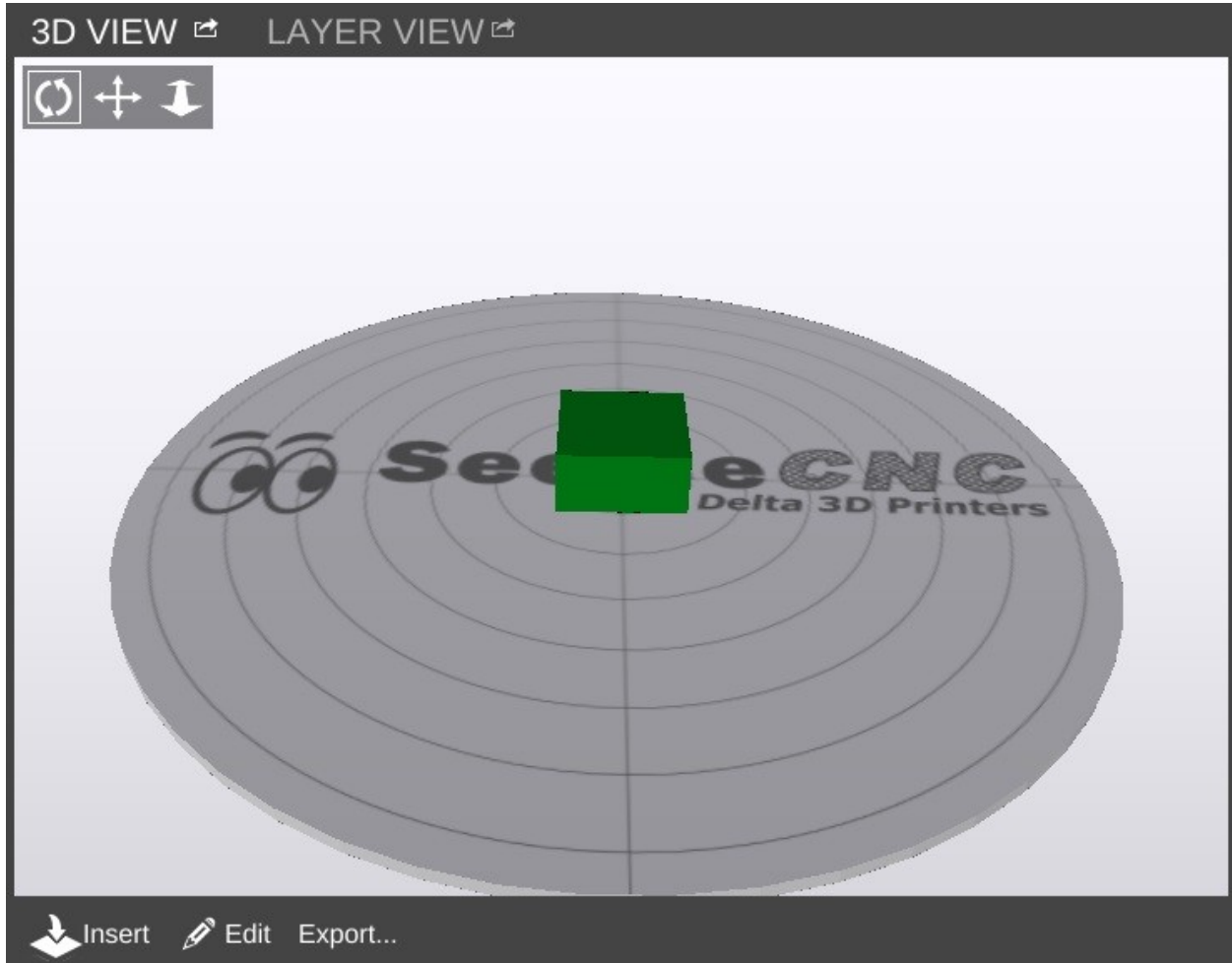



The 3D View.

The 3D View will allow you to view your model in pretty much any orientation you'd like. The view orientation is controlled one of two ways. You can select one of the movement icons

 in conjunction with the left mouse button. The first icon will allow you to “free rotate” the model and build platform. The second icon will allow you to move the part and build platform left and right, as well as up and down. The third icon will allow you to zoom in and out.

Rostock MAX v2 User's Guide

You can use the mouse by-itself as well. Holding down the left mouse button will allow you to “free rotate” the model and bed. Holding down the mouse wheel will allow you to move left and right as well as up and down. Spinning the mouse wheel will zoom in and out.

The 3D View will also allow you to directly manipulate the part or parts currently being displayed on the virtual print bed. The first control, **Insert**  Insert  Edit  Export... is used to add one or more components to the virtual print bed. To give you an idea of how this works in practice, head over to Repables and grab the “Ignite Michiana” object – <http://repables.com/r/146/>.

MatterControl is pretty smart – you don't have to extract the STL file from the ZIP file. Click on **Insert** and navigate to where you saved the downloaded zip file and select it. When the file is loaded, your screen should look something like this:

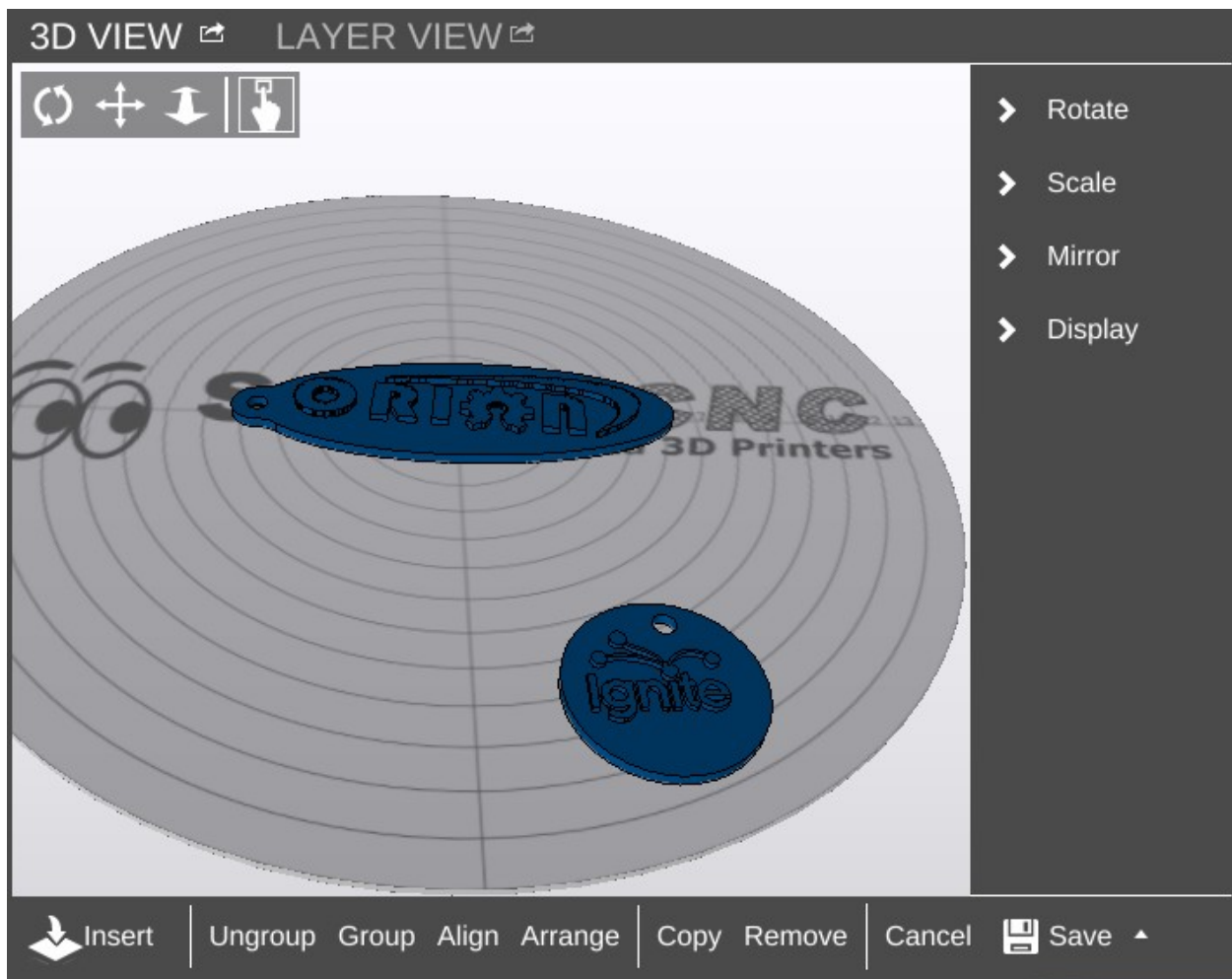

Auto-arranging parts.

If you didn't already have the example cube loaded, you may only see one object in the center of the bed. If this is the case, go ahead and load another Ignite object. If you can't see the object you've just loaded, click the **Arrange** button to automatically move the objects to the virtual bed.

You'll end up with something similar to the figure below after clicking on **Arrange**.

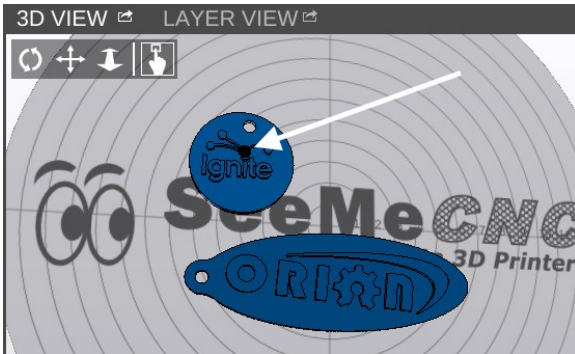

Object selected.

The white arrow points to a tiny icon that indicates which is the currently selected object. If you tilt the platform (right-click and drag your mouse), you can see that the icon is actually a tiny cone or arrow.

In order to move an object around manually, you'll need to make sure that the “picker” icon has been selected.



Once you've clicked on that icon, you'll be able to move the parts any where you like. However, be aware that the software will allow you to move the objects outside the confines of the virtual bed and they will not be printable outside of those limits.

You'll notice that you've got some new controls along the bottom of the 3D View window – **Ungroup, Group, Align, Arrange, Copy, Remove, Cancel, and Save**.

The **Ungroup** button will undo the “grouping” done by the **Group** and **Align** buttons.

Clicking **Group** will virtually connect all the objects on the print bed so they can be moved all at the same time.

The **Align** button has the same effect as the **Auto-Arrange** button, but the resulting group of objects are not centered on the virtual print bed.

Arrange will auto-arrange the parts in a grid pattern.

Copy allows you to create duplicates of objects that are on the print bed as shown below. Make sure that you've got the object you want to copy selected before you click the **Copy** button.

Be aware that if you've got your objects grouped, clicking on **Copy** will result in the entire group being copied.

The **Remove** button works as you'd expect. Select an object and click **Remove** to remove it from the virtual build surface.

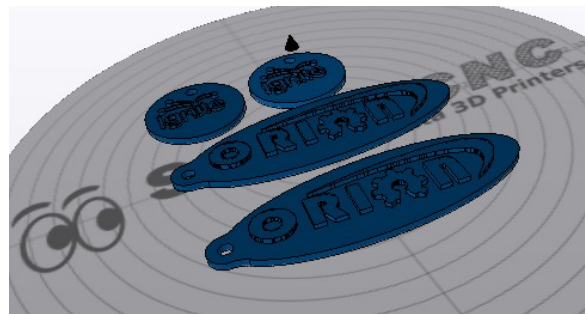

Copied objects.

Cancel will discard any changes you've made so far and **Save** will allow you to save the state of the virtual print surface. Saving your work saves it to the print queue. If you'd like to save your work as a combined STL file

While you're in edit mode, there's a series of commands that become available along the right edge of the 3D View pane.

Unlike normal manual positioning, the **Rotate** function allows you to specify the exact rotation of the object along its X, Y, and Z axes.

In order to change the orientation of the object, simply enter the value you want in the **Degrees** field and then click the axis you want to apply that value to. Below is an example of what the example cube looks like after rotating it 45 degrees along its X axis.

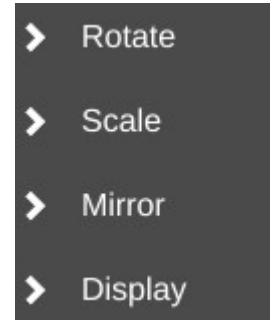
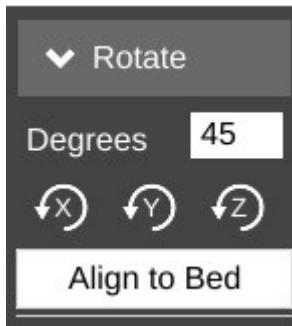

Being able to re-orient the part on the build surface can be handy to have, especially if you're dealing with a part that was saved in a position that didn't lend itself to easy 3D printing.

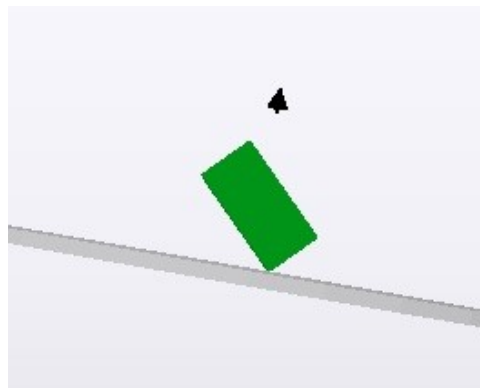

Tilted object.

Clicking **Align to Bed** will automatically orient the nearest flat surface to the virtual build platform.

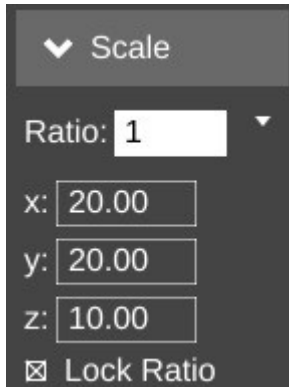

The **Scale** function will allow you to change the width, height and length of the part or parts currently on the virtual build platform.

The **Ratio** field allows you to shrink or grow an entire model by a specific percentage. For example, if you were to change the **Ratio** from 1 to 1.5, you'd see this:

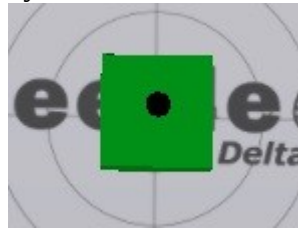

Become this:

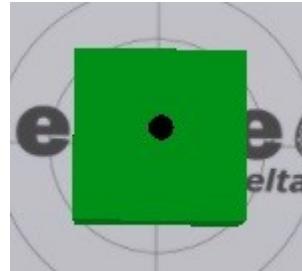

The scaling operation made the cube 150% larger than the original. The **X**, **Y**, and **Z** fields allow you to specify exact dimensions. However, as long as the **Lock Ratio** field is checked, any change made to those fields will adjust the others to maintain the same ratio.

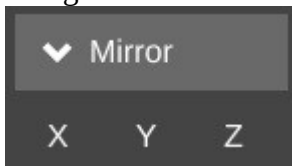

The **Mirror** function will simply allow you to “mirror” the object along any of the three axes. Note that mirroring the **Z** axis will flip the part upside down, so be careful.

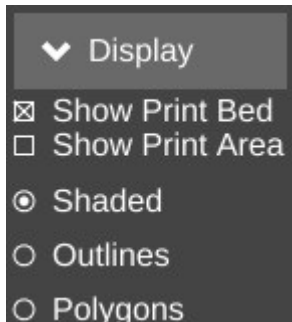

The **Display** function allows you to modify how the 3D View pane operates. **Show Print Bed** is pretty obvious. Uncheck it and see what happens! **Show Print Area** is handy when you want to see exactly how much space your parts are going to take up. When selected, it will display a shadowed cylinder that encapsulates the maximum bed diameter and print height, as show below.

The **Shaded**, **Outlines**, and **Polygons** options allow you to change how your objects are drawn. By default the **Shaded** option is checked. For most parts this is fine, but if you'd like to see detail that the solid shading can hide, click **Outlines**. Models used for 3D printing are built out of a few up to many thousands of polygons. If you'd like to see what the polygons look like that make up your model, click the **Polygons** option.

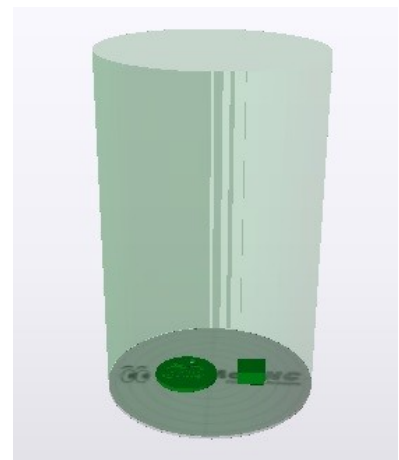

I find that the **Outlines** display option is the most useful as it makes part details really stand out.

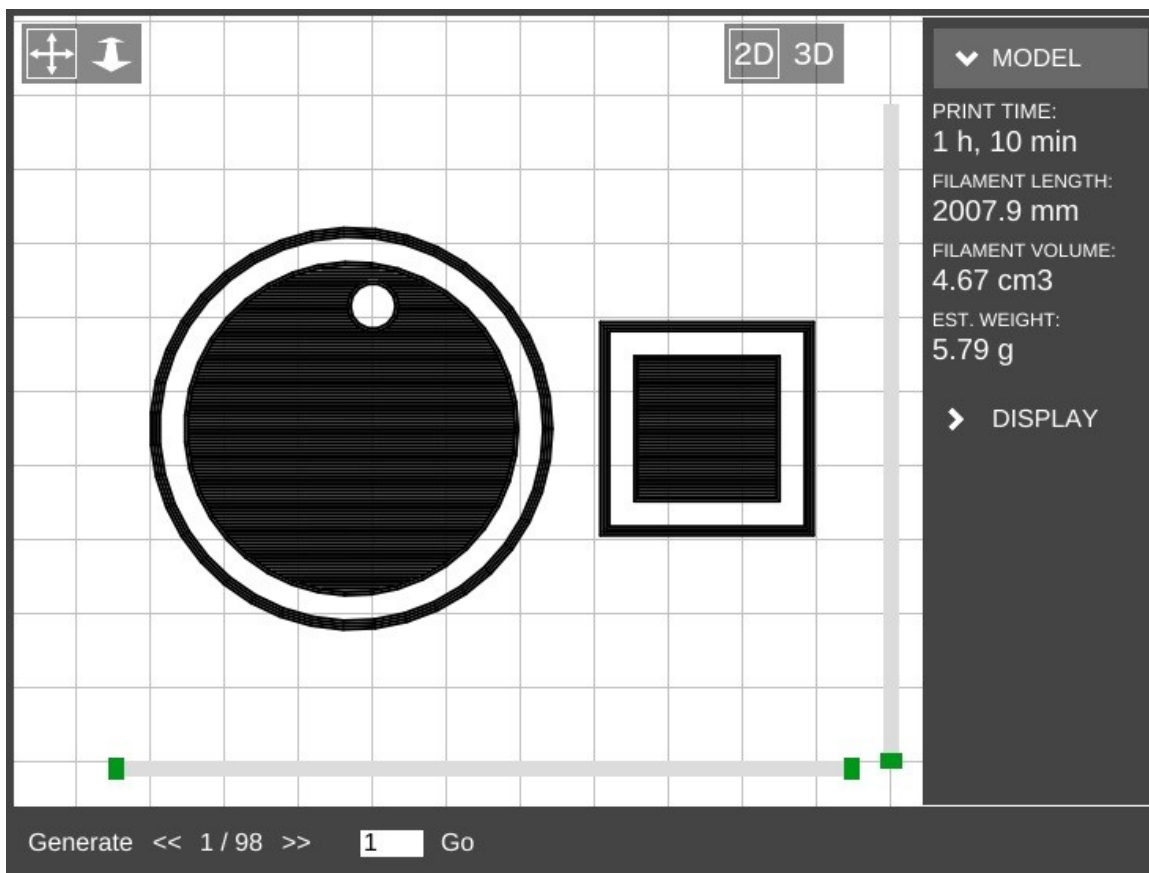

The Layer view.

The **Layer View** is where you can see exactly what the Rostock MAX is going to do while printing your part. When you first select it, it may show “**Press 'generate' to view layers**”. Click the **Generate** button in the lower left corner of the Layer View display.

Rostock MAX v2 User's Guide

This will hand over the parts to the slicing engine and will create the G-Code required to print your parts. In the image above, you can see that the parts have been sliced and layer #1 is being displayed.

Along the right side of the display, you'll see a printing time estimate as well as an estimate of how much filament will be required to print the two parts shown.

There are two “scroll” bars shown in the Layer View. The bar along the bottom will show progress of the current layer, while the vertical bar will show layers. Using the << and >> buttons along the bottom, you can step through the layers one at a time, or jump to a specific layer and click on the **Go** button.

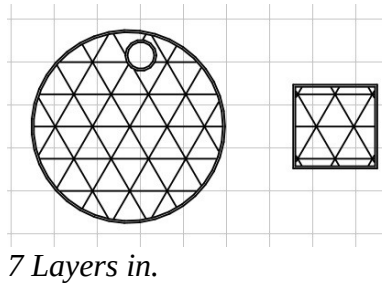

The Layer View will also allow you to see the layers in 3D. Just click the **3D** icon at the upper right corner of the display window to see your layers in 3D! The display can be moved around in the same manner as that shown for the 3D View.

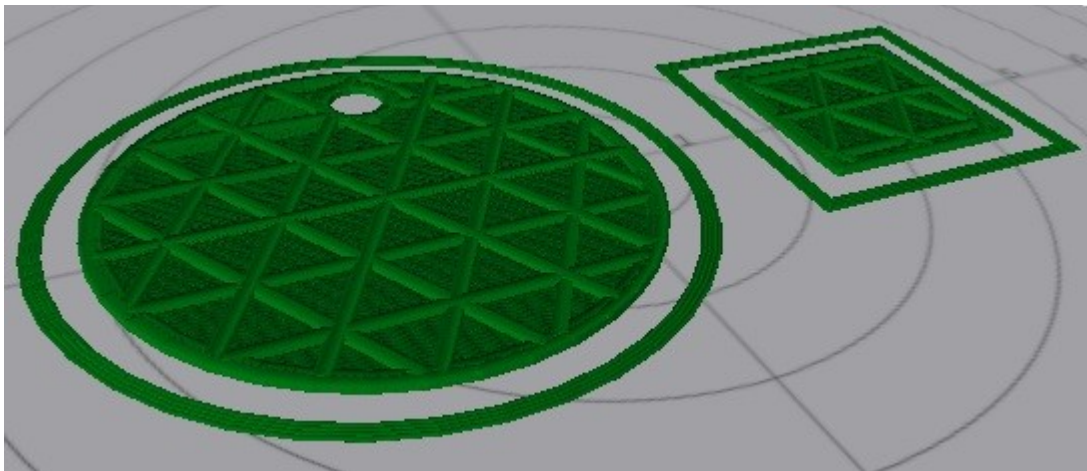

7 Layers in, 3D view.

The Layer View will also display other information about the printing process, such as non-printing movement, retractions, etc. Click on the **Display** button to the right of the display to open up those display options.

Grid hides or displays the virtual print surface.

Moves will show you the path the print head takes when it's *not* printing, as shown by the light green lines in the image below.

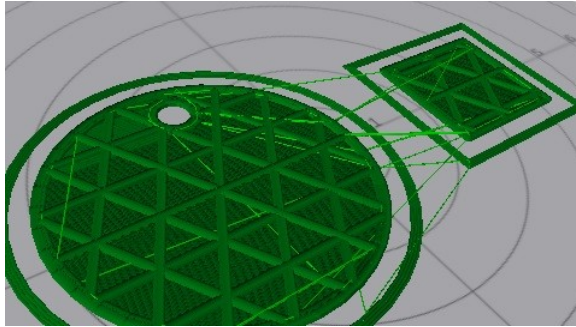

Travel moves.



Retractions show the points in the print where the extruder is going to retract filament from the hot end. This is done either during a non-printing move, or when changing extruders.

The red and blue points in the image to the right show where the retractions are happening.

Red shows the retract operation while the blue color shows the resume/extrude.

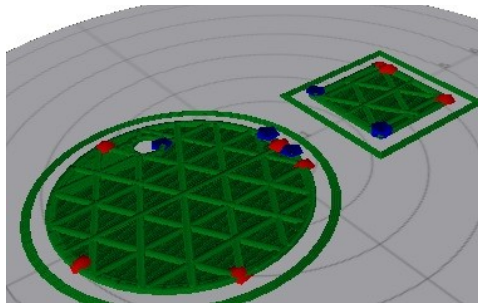

Retracts.

Speeds will color the layers based on how fast the layer is printed.

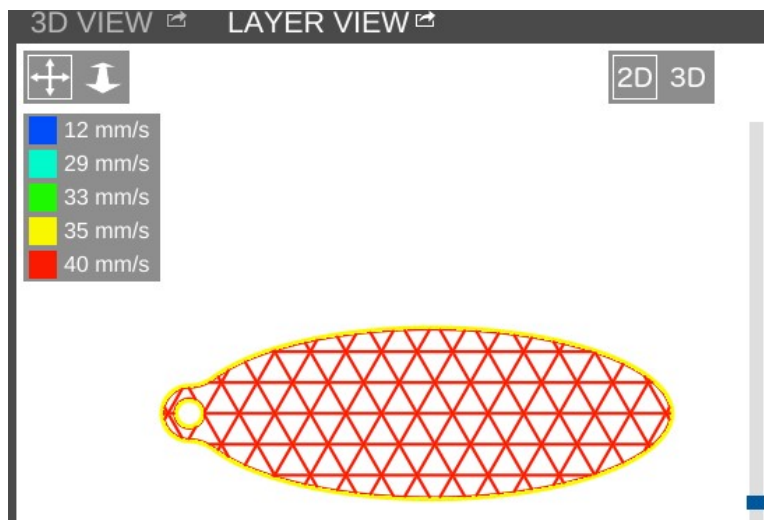

Layer speed.

Rostock MAX v2 User's Guide

The **Extrusion** option will thicken the lines used to draw the layers in order to give a more accurate visual representation of what the actual print layer will look like when printed.

Finally, **Sync to Print** will allow you to follow the print process using the Layer View. As the Rostock MAX prints your part, you'll see a real-time reflection of those moves. It's a pretty nice feature.

12 – A Strategy for Successful (and great!) Prints

Michael Hackney is one of our forum moderators over at the SeeMeCNC forum and he's been gracious enough to allow me to publish his wonderful guide for getting the most out of your SeeMeCNC 3D printer. You can find his original thread here:

<http://forum.seemecnc.com/viewtopic.php?f=36&t=7361>

Some of the links below reference part files that are stored on the forum itself. You may need to create a forum account to reach them. I highly recommend doing this whether or not you need the files. The SeeMeCNC is an excellent resource with a vibrant, helpful and very newbie-friendly community.

I've watched folks struggle to achieve the results they want/expect here for several years – heck, I was one of us. Like all new endeavors, there IS a learning curve with 3D printing. This is still the pioneering era for desktop printing and we are very fortunate to have such a great community here as well as other resources on the web. But the challenge with all the information out there is finding it when **YOU** need it and deciphering the many different opinions and practices - some of which are good and some of which are, well, let's just say "poppycock".

There are many different means to the same end but I assert that those who figured something workable (AND reproducible) out most likely took a disciplined approach to reach their goals rather than the shotgun approach of trying one thing after another. So, I thought it would be helpful to describe a method that you can use to 1) develop a reproducible approach to successfully printing the things you want and 2) improving the quality of your prints to meet your (realistic) expectations. I'll likely do this as a series of posts starting with this one. Don't hesitate to join in or ask questions. After some time, I'll consolidate the posts into a single source (maybe a pin here) that will make it easy to find.

On board? Let's go!

#1 Get Experience.

Start with the printer. This is more difficult than it seems because without experience, it is hard to know if you have a mechanical or electrical issue, slicing issue or if something else is going on. So, to that end, keep things simple until you have some experience. By "simple" I mean, don't print the Eiffel Tower model to start, print a simple, reproducible and small item many, Many, MANY times until you nail it. For me, I used the calibration cube. In retrospect, I should have picked something much simpler (see strategy #2).

#2 Start Simple.

We have a tendency to want to jump ahead to more complicated prints, faster printing, bigger prints, etc. There are many aspects to successful 3D printing, everything from the printer (which in itself has a mechanical system, electronics system, hot end, extruder, heated bed, firmware), to the slicer (and all of the parameters available to control the slicing), to the filament itself, to the actual item being printed. With so many variables (100s, maybe 1000s of them) it is really important to pin down as many of them as you can.

One very easy place to do this is with the model itself. Develop your experience printing the same model over and over until you nail it. Even with a simple model, you can (and should) approach printing it with a methodical approach from the ground up. That's the next strategy.

#3 Practice in Measures.

I play guitar and was basically self taught. When I found new music to learn, I did what many untrained folks do and practiced the part over and over again from beginning to end. If I made a mistake, I started over. Then, I took lessons from a trained musician. My very first lesson was worth every penny! My instructor watched me learn a piece and then said "Practice in Measures". What he meant by this was to learn the first measure (music is divided into small blocks of notes called measures which are small and relatively simple). Practice it until it is perfect. Then, practice the second measure until it's perfect. Next, combine the first and second measures until that is perfect. Continue in this way until you've learned all the measures and combinations of them. In complex pieces, there will be a few measures or sequences of measures where you need to put in a lot more practice.

The advantage of this approach, my instructor said, is that you are not wasting lots of time playing measures you already know. The practice of playing from the start until you reach a difficult spot and make a mistake is that you play, say, 30 seconds (or more) of music you already know to hit a 1 second spot you need to practice. So in a 30 minute practice session you are really only practicing what you need to practice for 1 minute! This completely changed my approach to practicing everything from guitar to 3D printing to machining to learning CAD, to...

How does this apply to 3D printing? Easily, start with a simple object to print and practice nailing the first layer. Once you have that nailed, print the rest of the object. Once you have the entire object printed successfully, change slicing parameters and start over (nail the first layer, ...). Practice in measures.

I can't say enough about getting that first layer right, the subject of the next strategy.

#4 Nail the First Layer.

I don't believe folks spend enough time learning to print a perfect first layer reliably. If there are defects in the first layer, they will invariably come back later to bite you – the part separating from the build plate or a defect in the part. Trying to print a good (or great) first layer is probably one of the most frustrating experiences for most, it is also the most critical. Here's where strategy #3 comes to play, don't continue a print on an inferior first layer! Abort the print and start that first layer again and again until you nail it. Why waste time on a part that will most likely fail or not be useful? Each time you print a first layer, *measure it!* If you tell your slicer to print a 0.20mm first layer, then it should be pretty darn close to 0.20mm. If it isn't, you've identified a variable that you can easily fix and nail down (Z height). 0.20mm is not a lot and unless you have highly calibrated eyes, you can't tell the difference between 0.20 and 0.15mm, but your printer sure can. At 0.15mm the first layer is going to squish onto the print surface.

It may even seem like you are getting a great first layer and great sticking (which you are) but later, you'll discover the part is nearly impossible to remove or your extruder will start making that all too familiar TICK, TICK, TICK sound from missing steps. A perfect first layer will go down smooth and consistently time after time.

TIP: polish the tip of your nozzle! Charred filament and scratches on the very tip of the nozzle are dragged over the layers as it moves around. Best case these leave a visible mark on the print, worse case they rip the first (or higher) layer off the build plate.

#5 Slow Down.

Back to my guitar lesson example... The other thing my instructor taught me in that first lesson was to practice slowly (using a metronome) until I nailed the measure(s) at a slow tempo. Then, gradually and consistently, increase the speed. The same applies to 3D printing, print slowly at first. This gives you time to observe what's going on (strategy #6) and just simplifies everything. I like to start new folks at 20 to 25mm/s print speeds. What's the hurry? If you print 10 aborted prints at 50mm/s what have you gained (or lost)? Printing slow helps all parts of the printer, from the mechanics to the extruder to the plastic filament coming out the nozzle, stay in balance or equilibrium. Fast movements can highlight mechanical issues, extrusion issues, etc. But when you are first starting out, you don't know how to identify and isolate these issues. In fact, even with all of my experience, if something starts to go wrong, I slow down. That removes a lot of variables and gives me a chance to see what's happening. I've identified everything from loose pulleys to a worn joint on a delta arm to separating arms on magnetic ball joints! And, I've helped a lot of folks identify other issues simply by slowing down.

#6 Watch What's Happening.

Especially in the early stages of learning, watch all aspects of the printer. Combined with strategy #5 you'll start to develop an appreciation for how the slicer does its magic, how the printer does its magic, and it is just simply fun to watch (especially a delta printer)! I highly recommend putting a flag of some type on your extruder so you can actually watch retracts and advances and watch the steady push of the filament. A piece of masking tape stuck to the shaft is fine or print one of the pointer models. Watch that first layer print, that's how you'll see if there is a problem and maybe even figure out why. For example, I noticed that the first layer wasn't sticking in the same spot on my build plate. Turns out that I had some potato chip grease there (don't ask)! A little wipe with Isopropyl alcohol and I was back in business. Watch what happens when the layer fan comes on. Is it coming on too early and causing the part to peel from the print surface? Pay attention to the details of what's going on and then...

#7 Keep Notes.

I can't stress how important it is to keep notes. I have a word processor file I add notes to as I go. In particular, I keep a section on the filaments I use and the detailed printing parameters for them (strategy #9). Perhaps I'm becoming forgetful in my advanced age but I don't like solving the same problem over and over again. If I keep a note about a problem and my solution, I can usually find it again pretty quickly. Once comment on notes, don't be afraid to purge! After a few years of doing this, my file got quite big.

Recently I archived all of my H1 and H1-1 notes. I don't refer to them any longer so why keep them in my working notes?

#8 Be Consistent.

A CEO friend I worked with many years ago was fond of saying "Consistency is the hobgoblin of small minds!". I understood what he was trying to say but it has to be taken into context. When you are first learning any new activity, it is critical to be consistent. If too many things are changing at once, you have no idea what contributed to a good or bad result. Don't change too many things at once. In fact, if you can isolate and change just ONE thing, you will have a much better chance of success and understanding. This isn't always possible so lock down as many things as you can. If after a run of successful printing you run into a problem, go back to a known good state (see #7 – you did keep notes on what this state was didn't you?) and start there. Many times we try to change too many things in our frustration and that almost always makes things worse. Step back and think about how to isolate the problem areas with as few changes as possible.

#9 Know Your Filament.

This strategy is a bit lower level than the previous eight but important and often overlooked. I see a lot of folks just assume that they should print filament X at temperature Z – for instance, print PLA at 200°C. This might get you in the ball park but if you really want to get consistent and GREAT results, profile your filament. It's easy and if you write it down (see #7) you'll never second guess how best to print that filament again. It's important to realize that higher temperatures are not always better, they can actually lead to issues - parts that are just a little too large, parts that stick to the bed too well and can't be removed, blobs on the print, stringing, and a host of other problems. In general, I like to print at the lowest temperature possible for PLA and ABS. Then, as I ramp up print speed, I also need to ramp up the hot end temp a little since the filament is not resident in the hot zone for as much time. I suspect little details like this cause people more problems than they might anticipate.

Here's how I profile a new filament:

- Start with a reasonable target temperature – 200°C for PLA and 225°C for ABS (one quick note, it is ideal to have a calibrated hot end, so when I say 200°C I mean 200°C. One easy way to do this is to make a little table with the hot end set temperature (what you see on the temp display) and the measured temperature (with a thermocouple). Do this in 5°C increments from 160° to 240° C (or so). Keep this chart in your notes (#7) and you will always know what the actual temperature is.)
- Now, use the manual controls of your host to extrude 50mm at 50mm/s and watch and listen.
- If the filament extrudes nicely, reduce the temperature by 5°C and wait for the temperature to stabilize.
- Test again by extruding 50mm at 50mm/s
- Repeat until you reach a temperature where the filament does not extrude well. At 5°C to that temperature and note this as the "low extrusion temperature" for that filament. Use this low temperature whenever you are printing slowly (20-30mm/s). You might find some filament need to be bumped up a bit more than 5° so don't hesitate to experiment and find that lowest reliable extrusion temperature.

If you want to get really serious about profiling your filaments, do the melt-flow test at higher extrusion rates – 60 mm/s, then 70mm/s, etc.

Don't forget to measure the diameter of your filament too! Not all filaments are created equally. Measure in several locations to get a sense of variability. Most of the slicers let you enter filament diameter and they will calculate a reasonable flow for you.

TIP: When you are starting a new print session, give the printer a little warm up exercise! Much like an athlete warms up before a game, don't just turn the printer on and attempt to print. Turn it on and let the hot end get up top equilibrium, let the heated bed get up top temperature. I even like to print a quick part (a 20mm diameter cylinder 5 mm tall) to make sure everything is up to temp, in equilibrium and working properly. It's quick and easy to do and can help eliminate a lot of problems.

#10 Know Your Bedfellows.

Probably one of the greatest mysteries in 3D printing is "the bed". Metaphorically, this is where the rubber (filament) meets the road (bed) and getting "it" right is absolutely critical to successful fused filament 3D printing. All sorts of folklore on bed materials, coatings, coverings, concoctions, and juju exists here and elsewhere on the internet. It is also one of the areas that there is no one right way to do it. If you have discovered a special incantation and bed preparation that works, by all means stick with it! But, for those of you struggling, here are some strategies you can use to make improvements. One comment before I begin...

I am VERY persnickety about the aesthetics of my 3D prints. My 3D printed fly fishing reel is seen from all sides and so it is important that the first layer is flawless and visually appealing. A perfect first layer finish is not required for all objects - consider the base of a Yoda or vase - but if you practice getting a great first layer on these non-critical pieces you'll be prepared when you need a visually perfect first layer on another project.

A number of factors affect adherence of the first printed layer to the bed. These include:

- surface material
- surface texture
- surface treatment/coating
- bed temperature and uniformity of temperature
- air temperature
- chemical bonding or cohesion
- print speed (see #5)
- filament temperature (see #9)
- first layer height (see #4)
- cleanliness (of bed and filament)

This isn't an exhaustive list but it does include the big hitters and, as you can see, there are a few of them so it is very important to take a methodical (#2 and #8) and documented (#7) approach when solving bed-related problems. This is also a place where careful observation (#6) can play an important part.

Rostock MAX v2 User's Guide

I'm not going to go through all of these in detail now but did want to comment about the last one - cleanliness. Whatever you do, make sure everything near and on your printer is clean and grease free. Silicone greases and lubricants are especially problematic since they are invisible and very difficult to remove. Keep them away from your machine.

Your fingers are a prime source of contaminants. Every time you touch the filament or bed, you risk leaving a greasy print (see my observation in #6) and these can (and will) cause issues. I try not to handle filament with my bare fingers, I use cotton gloves. If you use a plastic or rubber glove, make sure it isn't coated or powdered - we're trying to eliminate sources of contamination, not introduce them. On the occasions that I do handle filament with my bare hands I wash and dry them thoroughly first. This is one area that I think affects a lot of user's and is completely overlooked. How many times have you loaded filament right after eating chips? It introduces a big variable that can be difficult to track down, so develop good habits and eliminate contamination as a variable.

Your fingers can also leave contaminants on the bed when you remove a part or brush off stray filament strands. Don't touch the bed surface if at all possible. If you do, clean/degrease it with an appropriate cleaner. For uncoated surfaces like borosilicate glass, PEI, the various 3d party surfaces (PrintInZ and BuildTak), and films (window tint, Kapton) you can use Isopropyl alcohol. I like to use the little packages of wipes as they are convenient and safe. You can also do a quick wipe of your fingers before tossing it in the trash. It is more difficult to deal with coatings like PVA glue, glue stick, and hairspray since these can't be cleaned. If you suspect a contaminated coating, your only recourse is to remove and reapply it.

Finally, don't overlook filament storage, keep it clean too. I store mine in large zip lock bags to keep off dust. You can put packets of desiccant to help remove moisture in the bag too.

#11 Learn to Diagnose.

Patient: "Dr. it hurts when I move my arm like this."

Dr.: "Then don't move your arm like that!"

The first point of this joke is, many people do the same thing over and over again without making any changes or stopping to think about what to change (see #8: remember, change one thing at a time) - as if just repeating the same print with the same parameters will magically solve the problem. It won't (see my footnote below).

Rostock MAX v2 User's Guide

The second point of the joke is that the Dr. didn't attempt to actually determine why the patient's arm hurt, he just had him avoid the problem. I see that a lot too. Usually it takes the form of "I tried printing it with my red PLA and it failed but everything was fine with my blue PLA". There are many other variations on this (changing slicers for example).

Learn how to diagnose problems. This requires careful observation (#6). Once you've identified where the problem occurs (let's say getting the first layer to stick) then PRACTICE that piece (see #3) until you sort it out. No need to run through the entire process over and over. Isolate the problem, formulate a hypothesis on what you think might be happening and design a test to prove or disprove your hypothesis. If you see a problem and can't formulate a hypothesis THEN seek help! Or, pre-test your hypothesis here to get some experienced feedback. But, whatever you do, try to work through the diagnostic process yourself first, that's how you learn.

Footnote: Many years ago (20) my company had an annual laboratory safety week (I worked in a corporate R&D lab with lots of nasty stuff). One of the annual favorites was a gentleman from OSHA who talked about electrical safety. He started his presentation with a black and white video from the 1940s (I think) of a speaker walking up to a microphone on stage. The presentation was being filmed. The speaker reached up and grabbed the mic and was immediately thrown back and fell to the stage unconscious. Members of the audience rushed up to help him. This was all on video. As 4 or 5 people worked to help the victim, you see a gentleman casually walk up to the mic, reach out his hand and touch the mic. He was immediately thrown back and collapsed on the stage next to victim #1. Literally 30 seconds later a THIRD audience member walked up to the mic (now there are 2 victims on the stage and a hoard of people working to revive them) and *carefully* reached out his finger (looked like the scene from ET) and very, very gently touched the mic with just the tip of his finger. He was immediately thrown to the stage as the third victim. All of this was caught on video. No one died (we were told). Neither of the second two victims stopped to think about the problem, consequences or solutions.

#12 Be a Fanboy.

I am probably going to lose some fans for this post about cooling fans!

Don't think of a part cooling fan as an object. Instead, think about "air flow". If you need cooling on a PLA (or other material) part, then you need to understand air flow. Not all cooling fans are created equally. Consider this, some folks use a 40mm, some a 25mm, some (like me) a 25mm squirrel cage fan. Some are mounted to blow the full fan width stream at the nozzle area, some have a duct or some (like mine) have a very focused soda straw duct). So comments like "run your fan at 1/2 speed" are not specific enough to be useful information. Instead, you need to understand how your particular fan, it's arrangement, your material, etc, all relate to the air flow.

Firstly, using the previous strategies, try to minimize or eliminate the need for any sort of air cooling. Slowing a print down (#5) is one great way to do this. It also gives you a chance to see (#6) where any problem areas on a print might be. You can use this information to focus the *right amount* of air flow on the problematic areas. The tendency for many is to use as much air as possible. It is much better, more consistent, and more reliable to use as little air flow as necessary. This puts less thermal stress on the printed part.

When you do determine you have a problem that only a fan can solve, start conservatively. I also seriously recommend using a duct of some sort to focus the air flow where you need it. Ideally, the fan would have the ability to follow the print nozzle and direct a small stream of air to the filament right after it is laid down. That is a difficult problem to solve, so most of us direct the air to area around and under the nozzle. But, by directing the air (duct) you can reduce the air flow significantly since it is now focused where you need it. Here is an example of some of my fan research. The part on the left failed (in a previous run) as you can see due to warping caused by an uneducated 25mm inducted fan blowing at 50%. The part being printed on the right was my first attempt at using flexible soda straws (2 of them) to direct the air flow to exactly where I needed it. I also ran the fan at 20%

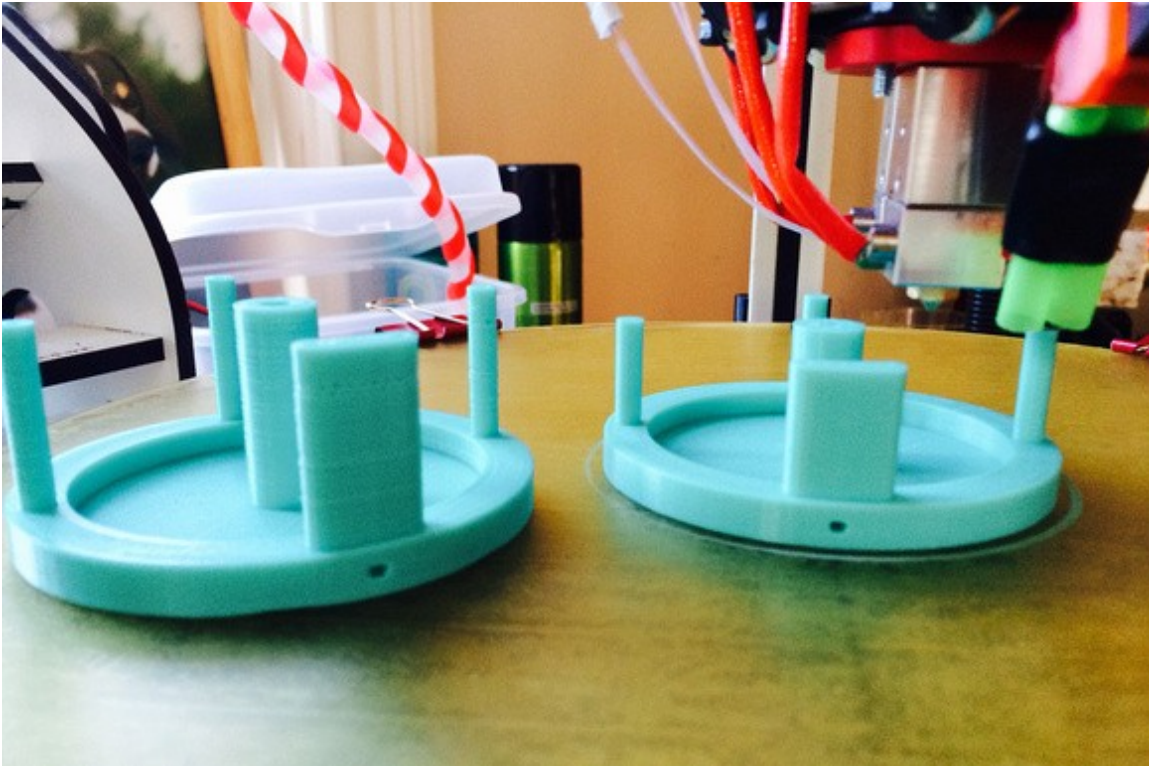

Fishing Reel parts.

The angle of the photo doesn't show it clearly but the "double barrels" are focused at the tip of the nozzle. The "dead air" space between the tubes prevents air from flowing over the nozzle. I know, it's terribly clever! It's a work in progress and I've almost got it perfected with a printed double barrel nozzle.

I suggest doing your own experiments and observations but start conservatively. I don't use a fan during the entire part. If you find you need to turn the fan on at full blast from no air flow, do it in stages so the hot end can equilibrate properly. You can do this manually, some slicers can support it, or it is easy enough to learn the simple "fan mcodes" to manually insert them where you need them in the gcode file (this is what I do for tricky parts).

M107 is fan off

M106 S50 turns the fan on at 50% - the S parameter is the speed from 0 to 100

Using a focused air flow, lower air flow and the step up technique I just described, you won't see a significant drop in hot end temperature and you won't see a tell tale sign on the part that the user 'Polygonhell' mentions. PLA has this interesting property that if you change the extrusion temp at the hot end, it has a visible effect on surface sheen of the part from matte to gloss as you raise the temperature.

[RichRap has written an excellent post](#) about how he uses this phenomenon when printing decorative vases. Although he was varying the hot end temperature, a similar effect can occur with improper air cooling.

I'm also an advocate of using off-platform cooling. By this I mean strategically placed (ducted) fans that direct air to problematic areas of a print. These can be mounted to your vertical columns or simply sat on the bed if it is not too hot. With ducting, you can reduce the air flow considerably and keep the cooling right on a "hot spot". This technique does require manual adjustment, repositioning, etc. But, if you are trying to print a really tricky part, it might be the only way to do it. Frankly, the part cooling capabilities of desktop 3D printers is extremely primitive at this point. It's fine for the majority of objects you might print but as we push the envelope on what's possible, part cooling is one area that needs some more work to automate it.

Consider this, the way I maintain very tight tolerances on the rotating spindle and hub assemblies on my fly fishing reels is to use a low beam of air cooling on the spindle as it's printed. This "locks" the filament in place in a very predictable way. Once I printed a few parts and measured them to make sure there was little variation, I incorporated that into the design to get exactly the tolerance these parts required.

Calibration things:

This first set is a 20mm diameter cylinder, 0.6mm tall. There are 3 variations and the all width is the first part of the STL file name. Start with the pt4mmx20mm-cylinder.stl if you have 0.4mm nozzle orifice. You can use these to:

- 1) get first layer adhesion to the bed
- 2) first layer thickness (stop the print after first layer and measure it)
- 3) total print height (should be about .6mm)
- 4) X-Y calibration (should be 20mm diameter)
- 5) eliminate blobbing and other surface artifacts - follow the guide above, print slow, adjust retracts, etc. KEEP NOTES!

pt3mmx20mm-cylinder.stl

<http://forum.seemecnc.com/download/file.php?id=8207>

pt4mmx20mm-cylinder.stl

<http://forum.seemecnc.com/download/file.php?id=8208>

pt5mmx20mm-cylinder.stl

<http://forum.seemecnc.com/download/file.php?id=8209>

pt6mmx20mm-cylinder.stl

<http://forum.seemecnc.com/download/file.php?id=8210>

[Highcooley's Onyx Bed Leveling Aid](#) is a great one to test your calibration. Highly recommended. If you can print it perfectly you've "arrived". I couldn't find a similar thing for the Orion. If you know of one, let me know and I'll add it.

texsc98 took the challenge and created a [parametric version](#) that has defaults for Orion.

Layer Tuning

You can use this set of files in a number of ways - everything from testing calibration results to exploring slicer options to breaking in a new filament. These are designed for a .2mm layer height.

The first cylinder (pt2mm tall) I call the Simple Single Layer Test and is my workhorse calibration object for tuning first layer adhesion issues, profiling new filaments and host of other uses. It is one layer high and can be used to test adhesion to the bed and first layer thickness (measure it with a micrometer or calipers and compare to what the first layer height was supposed to be). You can use this to tune your printer and slicing parameters to get perfect infill and explore the effects of speed on infill quality without wasting a lot of time and filament printing larger parts poorly. I also use it when I am testing a new filament to dial it in. It's a really versatile tool and I use it every day.

75mmDisk-pt2mmtall.stl

<http://forum.seemecnc.com/download/file.php?id=8475>

This cylinder is 0.4mm tall, or two layers. It can also be used similar to the first cylinder but the second layer will show issues in orthogonal movements to the first layer. It also provides a little more thickness to measure to verify layer height. It can also help tune the top capping layer.

75mmDisk-pt4mmtall.stl

<http://forum.seemecnc.com/download/file.php?id=8476>

The last cylinder is 0.6mm tall, or three layers. Again, it can be used like the first two. I don't use it as often.

75mmDisk-pt6mmtall.stl

Rostock MAX v2 User's Guide

<http://forum.seemecnc.com/download/file.php?id=8477>

Appendix A: Maintenance and Troubleshooting

Like any machine, your Rostock MAX 3D printer needs preventative maintenance to continue to function as good as the day you built it. Vibration and heating/cooling cycles can take their toll and you want to stay ahead of any issues before they begin to adversely affect your prints.

1. Check the condition of your drive belts to insure they're not getting worn out or rubbing on any of the Rostock MAX v2 structure. Check to make sure that a print too close to the bed hasn't caused the drive gear to chew up the belt in one spot. This would be a good item to add to your start-up checklist.
2. Check all bolted connections to ensure that vibration hasn't begun to loosen them. This should be part of your start-up checklist.
3. Make sure that the fan in the power supply remains dust-free. Vacuum it out periodically to prevent the buildup of too much dust. Dust traps heat and isn't any good for power supplies.
4. Keep the RAMBo free of dust. Clean it periodically with either canned air or a dry paintbrush. Do **NOT** use a vacuum cleaner on it! The tip of a vacuum cleaner accumulates static electricity and will kill the RAMBo dead as a post.
5. Keep the heated bed free of scratches and debris. If your bed gets too scratched up to be usable, you can either order a new one from SeeMeCNC or go to your local glass shop and order a 300mm diameter disc of glass, 1/8" to 3mm thick. Compare the thickness of the glass and your original build surface. If the glass isn't the same, you may need to re-adjust your Z axis height.

The problem with troubleshooting is sometimes trouble shoots back. :)

Your Rostock MAX v2 3D printer is a pretty complex piece of machinery even though it looks pretty simple. As with any complex device sometimes things can go wrong in really weird ways. This won't be a comprehensive troubleshooting guide, but will touch on a few of the problems I've run into with my printer. As others offer tips, they'll be added to this section.

Print Layer Issues

When you first start a print, you should get a very even and consistent layer height. By properly adjusting the machine, you should get this automatically if you've got all three towers adjusted exactly the same. Unfortunately, that's really difficult to do. The larger the object you print, the more obvious first layer thickness inconsistencies will be, especially when using loops.

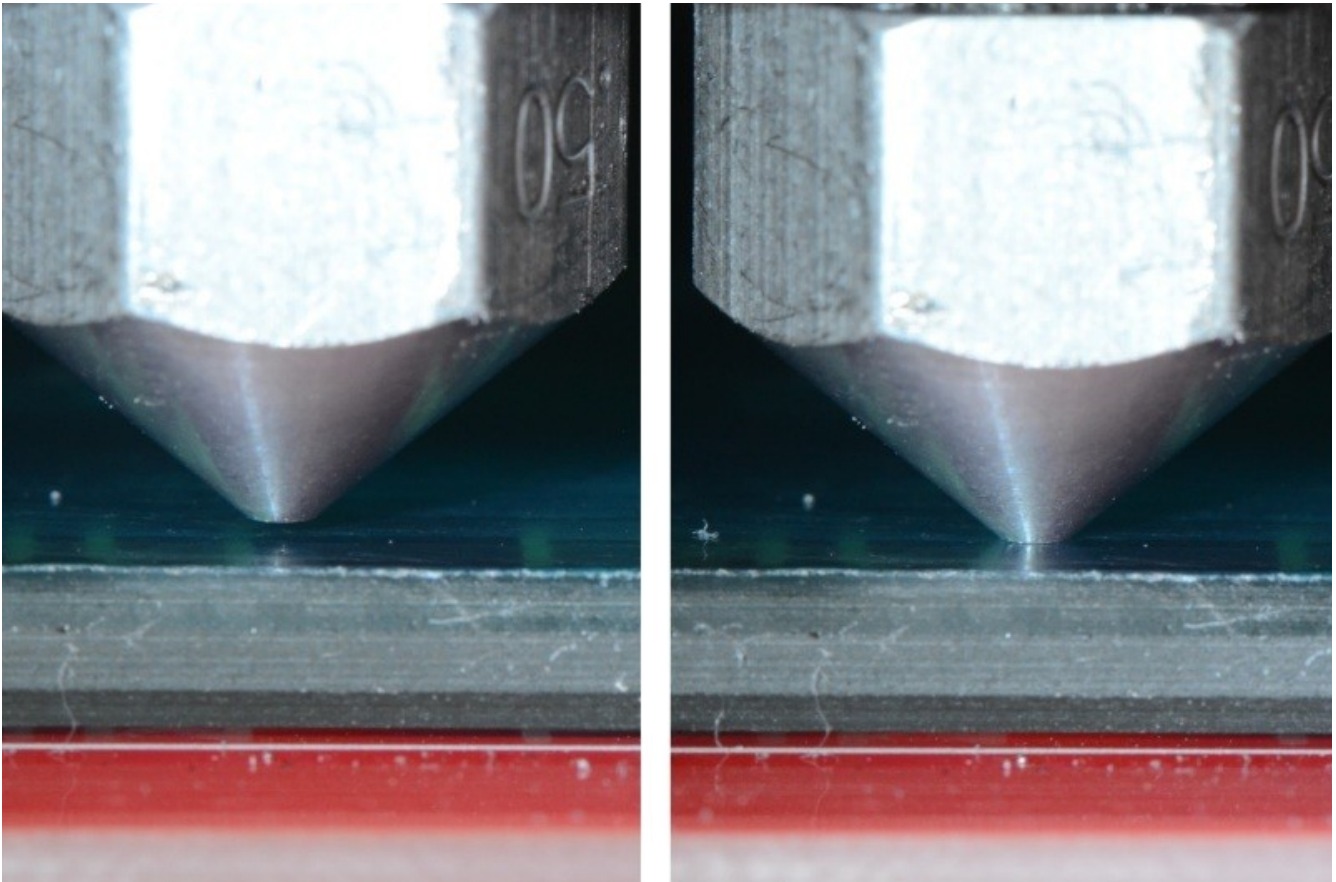

Nozzle height examples. (Image Courtesy of LulzBot)

Above is an example of correct and incorrect nozzle height. The nozzle on the right is right at the surface of the print bed. This means that there's no room for the plastic to go – the bed is effectively plugging the nozzle and will eventually cause the extruder to start skipping, or it'll grind a notch in the filament as it tries to feed it.

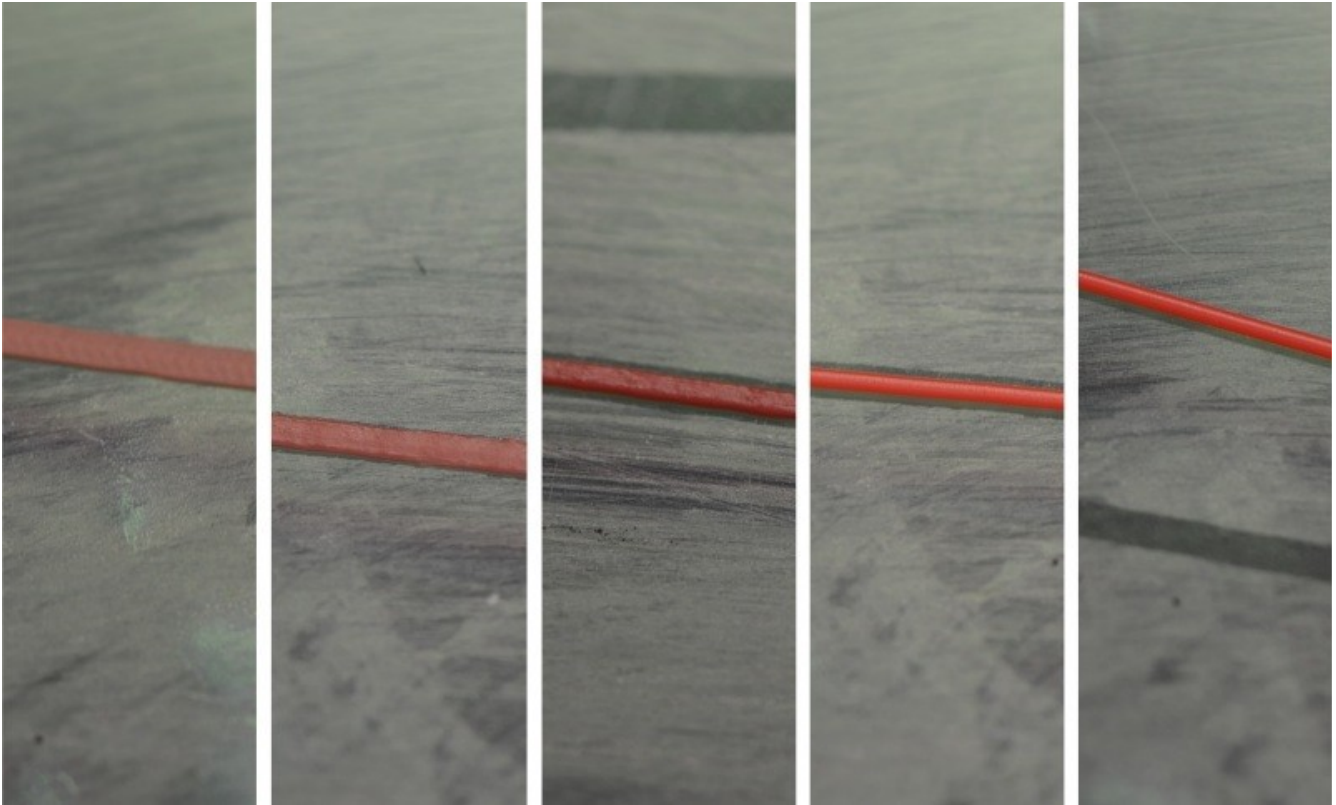

First print layer examples. (Image Courtesy of LulzBot)

In the figure above, you'll see five different print examples. On the far left you see the result of the nozzle being too close to the print bed, while at the far right you see the result of the nozzle being too far away. The result you're looking for is shown in the center. That's what a good first layer should look like. If you set the Z height such that you can just begin to feel a sheet of note paper begin to drag between the nozzle and machine bed, you're pretty close to the ideal Z height when at zero.

Machine Won't Move!

You've sent **G28** and the machine still won't move using the jog buttons. Take a look at the serial terminal output. You may be seeing an error go by that looks like this:

Extruder switched off. MINTEMP triggered!

What is most likely happening is that you haven't yet plugged the hot-end thermistor in. The firmware is preventing the machine from moving because of this – it's a safety measure of sorts. A cold thermistor will read ambient room temperature, but a failed one may not – it could read zero or some very high number. The firmware will prevent the Rostock MAX from operating if the thermistor readings are below 3 degrees Celsius for the hot end and heated bed, or if the hot end temp is above 275 or the heated bed is above 140. (These are defaults and shouldn't be messed with unless you know *exactly* what you're doing)

LCD Panel Not Working

The LCD interface in the Rostock MAX v2 is a pretty simple device – there's not a whole lot that can go wrong with it. The most common issues involve either the display not lighting up or the knob not properly operating. Both of these issues boil down to a wiring issue. ***Remember, before working on your Rostock MAX v2, make sure you turn off the power!***

First, check to make sure that the small interface PCB is properly installed on the RAMBo. It's pretty easy to get it on there shifted to the left or right by one pin. (Rare, but it can happen.)

Next, you need to make sure you've got the cabling between the LCD and the interface board installed properly.

If you've got an LCD controller that has a white PCB, you'll need to make sure that the red stripe on the ribbon cables are on the right side as shown below.

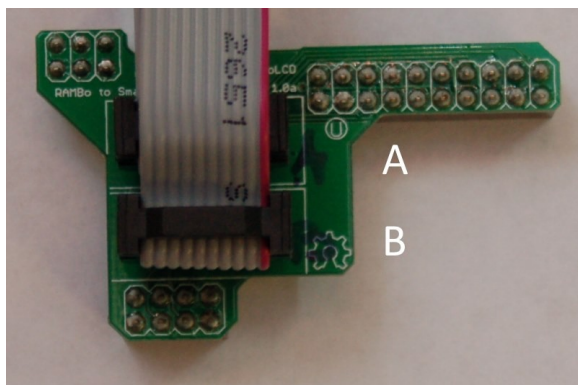

Cabling for white PCB.

If you've got an LCD with a red or blue PCB, then the red stripe should be on the left side.

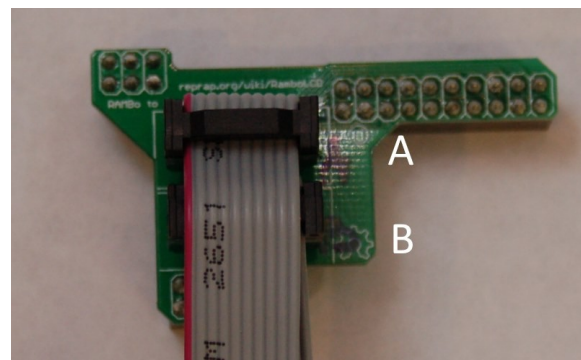

Cabling for red or blue PCB.

Rostock MAX v2 User's Guide

You should also make sure that the cabling from the LCD to the small PCB goes to the correct connectors.

Make sure that your “A” and “B” ribbon cables match the locations shown on the prior page as well as those shown below.

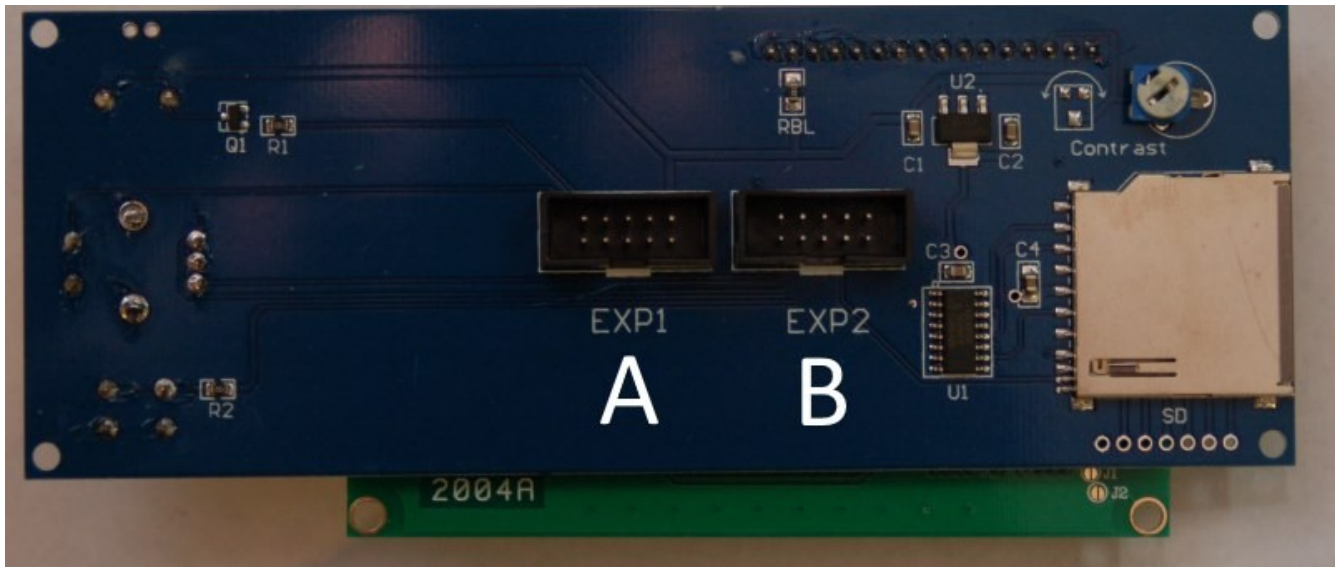

"A" and "B" ribbon cable positions.

If your LCD still isn't operating properly after you've verified the ribbon cable is oriented and installed properly and the LCD interface board is properly installed, start over! Remove the ribbon cables from the LCD, remove the adapter from the RAMBo and the ribbon cables off the adapter. Carefully re-install the ribbon cables and the RAMBo adapter and see if things work. The idea here is to ensure that your problem isn't caused by a loose connection.

Appendix B: Alternate Calibration Method

The calibration method I'm going to outline here was originally used in the 2nd Edition of the Rostock MAX v2 Assembly Manual. With the introduction of the 3rd Edition, it was requested that I utilize the same calibration process that the fine folks at SeeMeCNC use when calibrating the Orion printers after they're built. Both methods achieve the same result and I'm merely including this alternate method for those that are interested in using it.

Note that unlike the original process that used a sheet of notebook paper, I want you to use a 0.009” feeler gauge. The photo below is the style you want to get:

Note that if you get a set that doesn't include the 0.009” gauge, you can use one similar in thickness.

It may be easier to use if you remove the feeler gauge leaf from the set and rub the oil off of it – you don't want the protective oil from contaminating the glass bed. It will “re-oil” itself once it's replaced in the pack of gauge leaves.



Fig. A-1: Typical feeler gauges.

The first thing you'll do is create four new macros within MatterControl.

Create and name macro #1 “Z Tower” and use the following G-Code:

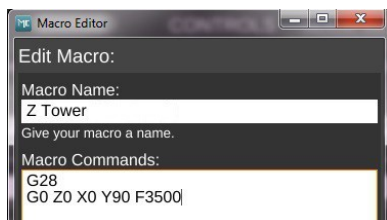

Fig. A-2: Z Tower.

G28
G0 Z0 X0 Y90 F3500

Create and name macro #2, “Y Tower” and use the following G-Code:

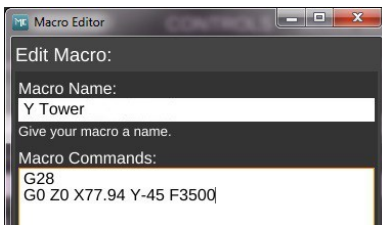

Fig. A-3: Y Tower.

G28
G0 Z0 X77.94 Y-45 F3500

Create and name macro #3, “X Tower” and use the following G-Code:

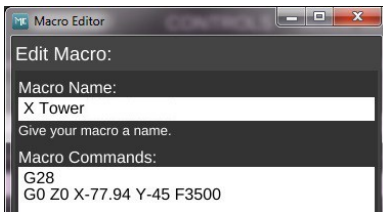

Fig. A-4: X Tower.

G28

G0 Z0 X-77.94 Y-45 F3500

Create and name macro #4, “Bed Center” and use the following G-Code

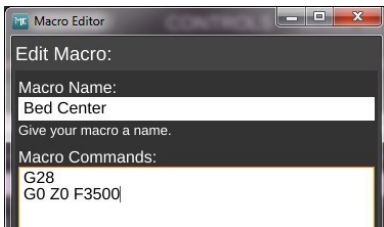

Fig. A-5: Bed Center.

G28

G0 Z0 F3500

In order to make sure that each axis is higher than the destinations of the four macros you just created, I want you to position the machine using the terminal window. Enter these commands using the G-Code Terminal:

G28

G0 Z5 X0 Y90 F3500

Perform the same check on the other axes by issuing **G28** followed by **G0 Z5 X77.94 Y-45 F3500** and **G0 Z5 X-77.94 Y-45 F3500**. You're not after accuracy at this point, you just want to get the nozzle from smashing into the build plate.

Once you're confident you can go to the heated bed without striking it, you can begin to precisely adjust the end stop screws.

Click the “**Z Tower**” macro button. This will send the g-code you entered previously to the Rostock MAX. Make sure you've got your feeler gauge under where the hot end will “land”. Having these in macro form makes the repeating task of setting the end stops much easier.

Your goal here is to have the nozzle touching the feeler gauge just enough that you can feel the additional friction of the feeler gauge “dragging” under the nozzle. You want that same amount of “grab” to be equal among all your test locations.

You adjust the height of each axis by turning the end stop adjustment screw to the right to **raise** the platform and to the left to **lower** the platform. Each time you make an adjustment, click the “**Z Tower**” macro button. Repeat this process until you're getting the same amount of “grab” on the paper as you did when setting the initial Z height. When you're satisfied, move on to the “**Y Tower**” and “**X Tower**” macros.

Rostock MAX v2 User's Guide

Set your feeler gauge on the center of the build platform and click on the “**Bed Center**” macro button. The nozzle tip is going to end up in one of three positions. It's going to be above your feeler gauge a visible amount, it's going to pin the gauge firmly to the bed, or if you're incredibly lucky, it will be “gripping” the feeler gauge the same amount as the tower base calibration steps. If it IS, I *strongly* recommend you go buy a lottery ticket. Your luck is *just that good*. (If you win, I want a cut!)

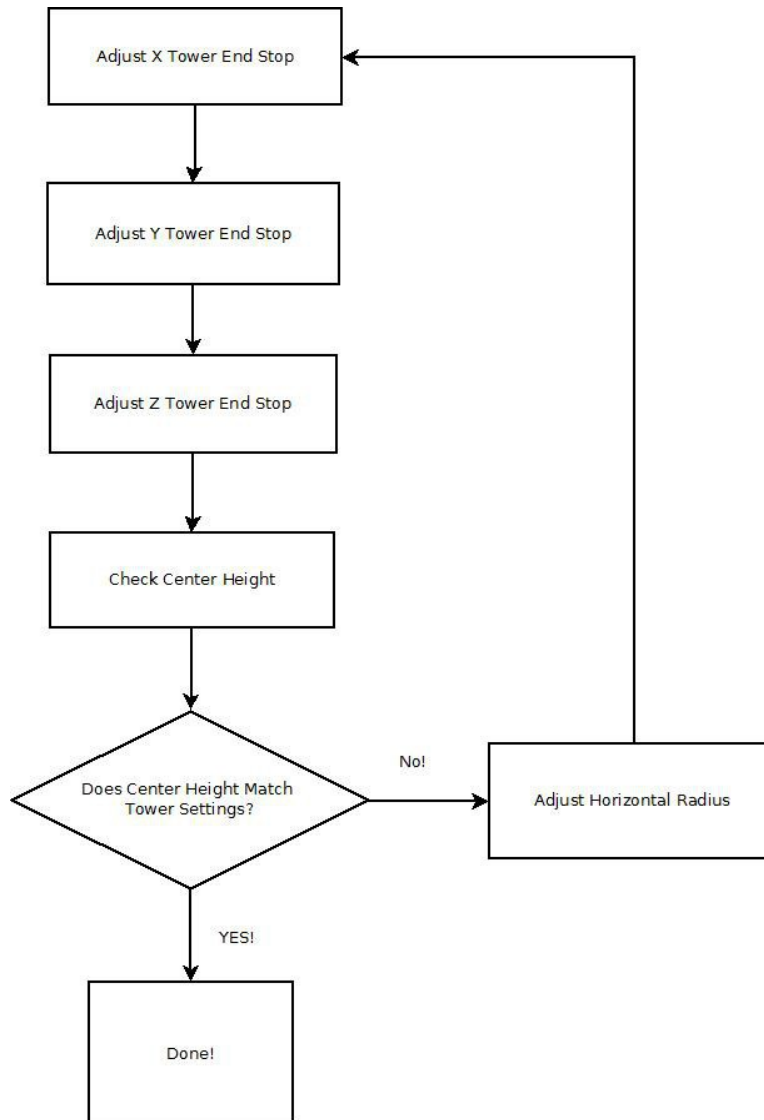

Fig. A-6: Calibration Flowchart.

Rostock MAX v2 User's Guide

If you're a mere mortal like the rest of us poor suckers, you're going to have to make an additional adjustment. Delta configuration printers like the Rostock MAX v2 have a very interesting geometry that will result in the hot end traveling in a non-flat path if it's not perfectly calibrated. This tiny error will express itself as a “virtual” convexity or concavity in what it thinks the bed shape is. If your hot end is pinning the feeler gauge to the build surface, the error is expressing itself as a concavity – the firmware thinks that it is moving flat, but the path of the hot end is actually concave and that's why it pins the feeler gauge to the build surface – the center is actually lower than it should be. The reverse is also true – if the hot end is not touching the paper at all, it thinks that the bed is dome shaped (convex). This all boils down to what happens when the “perfection” of mathematics runs face-first into the “imperfection” of reality. :)

The concave/convex shape of the bed is controlled by the EEPROM table entry labeled “Horizontal radius [mm]”.



Fig. A-7:Horizontal Radius value.

What you're going to do is change that figure by 0.5 until the nozzle is touching the paper just the same as it was when you calibrated at the base of each tower.

In order to lower the nozzle, you'll need to **increase** the Horizontal Radius value.

In order to raise the nozzle, you'll need to **decrease** the Horizontal Radius value.

Each time you change the Horizontal Radius, you must re-calibrate the base of each tower as you did in the previous steps using all four macros in the Z, Y, X, Bed Center order.. It may take a number of iterations to get the center nozzle height nailed down, but it IS worth the hassle. Your first layer quality and plastic adhesion require that the nozzle track across the entire bed as perfectly flat as it can.

Please make sure you click the **Save To EEPROM** button each time you make a change, otherwise the new Horizontal Radius value will not take effect!

That's all there is to it!

Appendix C: The MatterControl Touch

The MatterControl Touch is an Android based, 7" touch screen tablet that you can use in place of a desktop or laptop computer. The features offered by the MatterControl Touch are essentially the same as MatterControl. You'll get the same excellent feature set that MatterControl provides, along with the ability to use the back-facing camera to take pics of your print jobs when they finish. For a full list of what the MatterControl Touch can do, check it out on the MatterControl website: <http://www.matterhackers.com/store/printer-accessories/mattercontrol-touch>.

One thing that you'll really appreciate with the MatterControl Touch is the ability it gives you to run your Rostock MAX v2 without having to depend on having a desktop or laptop computer handy. This Appendix is going to go over what you need to do in order to get the most out of your new MatterControl Touch tablet and your freshly built Rostock MAX v2 3D printer!

The first thing you'll want to do is download and print the MatterControl Touch mount. This mount is the same for both the Rostock MAX v2 and the Orion. You can find it here: <http://repables.com/r/497/>.

You can “plate” the four smaller parts like shown on the right. None of the parts require support, except for the “MCT Tablet Mount” component. However, that part has support designed-in, so there's nothing you need to do in order to add support. I would recommend that if you're printing with ABS that you add a 5mm or so brim to the smaller parts job in order to help them stick to the bed. That's how I printed mine and they turned out great!

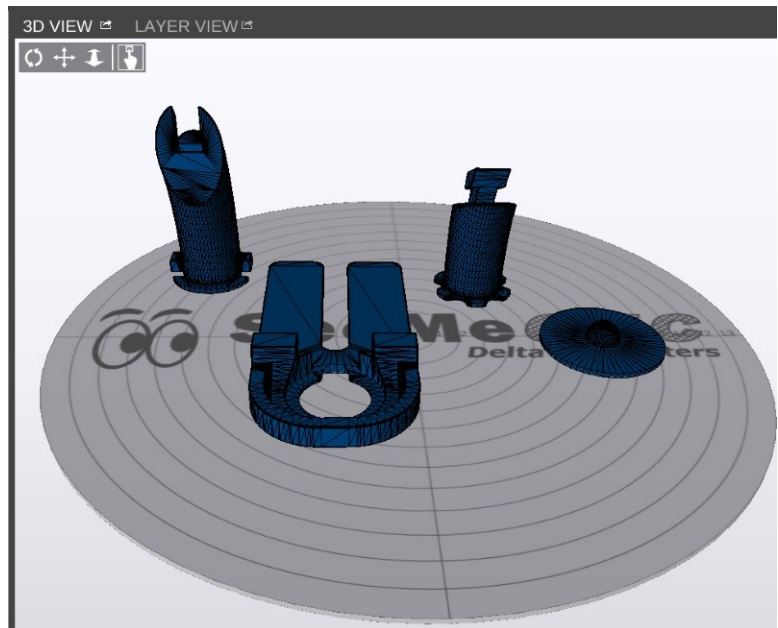

Plating the smaller parts.

Rostock MAX v2 User's Guide

As I mentioned previously, the tablet mount itself has designed-in support, as shown below.

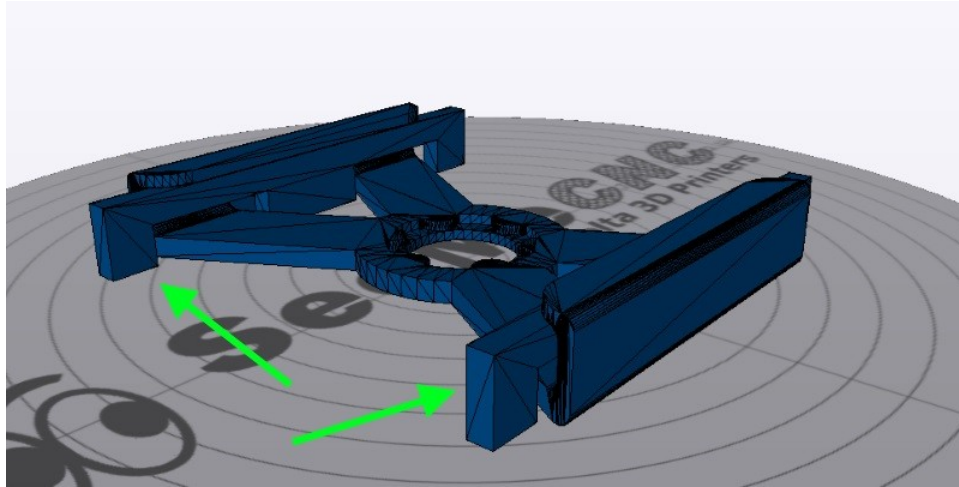

Designed-in support structures.

When you're done printing this part, the supports can be easily removed without damaging the tablet support.

Here's what the printed tablet mount components look like.



Successfully printed tablet mount components.

Rostock MAX v2 User's Guide

Once you've got the parts cleaned up, you'll need to assemble them. Begin by inserting the Arm Base into the Base Mount as shown below.



Base Mount & Arm Base.

The Arm Base is inserted into the Base Mount from below. Once it's flush as shown to the left, you can rotate the Arm Base 90 degrees into the "installed" position.



Arm Base ready to rotate.



Arm Base in installed position.

Set these parts aside and we'll move on to installing the Arm Top into the Tablet Mount.

Rostock MAX v2 User's Guide

Insert the Arm Top into the Tablet Mount from the front as shown below.



Arm Top inserted into Tablet Mount.

Rotate the Arm Top such that when the tabs are aligned with the pockets on the Tablet Mount, the tip of the Arm Top is pointed “down” as shown below:



Arm Top orientation.

When you've got the Arm Top oriented properly, press it into the arm seat on the Tablet Mount so that it's flush with the upper surface of the Tablet Mount as shown below.



Arm Top fully seated.

Rostock MAX v2 User's Guide

The Tablet Mount is designed a bit over-sized and won't properly hold the MatterControl Tablet without a little help. This is where the Tablet Bumper comes into play.

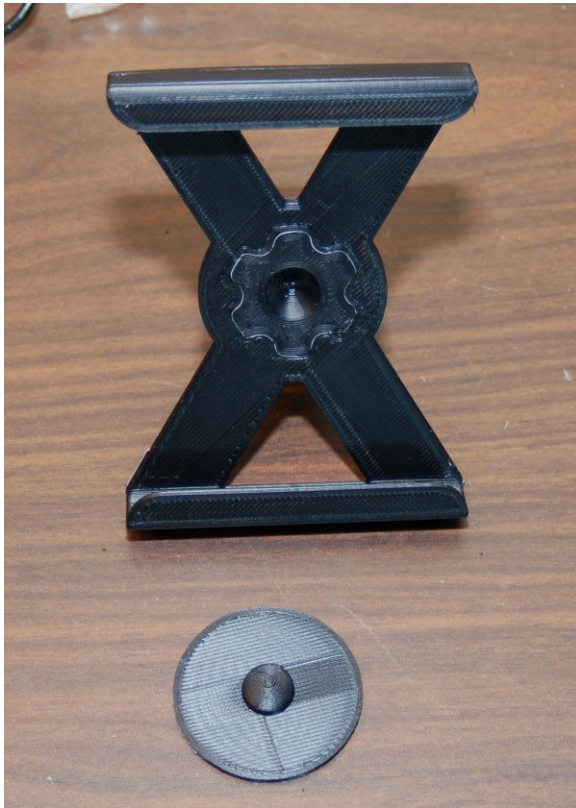

Tablet Mount & Tablet Bumper.

The bump on the Tablet Bumper fits into the shallow pocket in the center of the Arm Top. When you slide your MatterControl Touch tablet into the mount, the Tablet Bumper will ensure a snug fit into the mount.

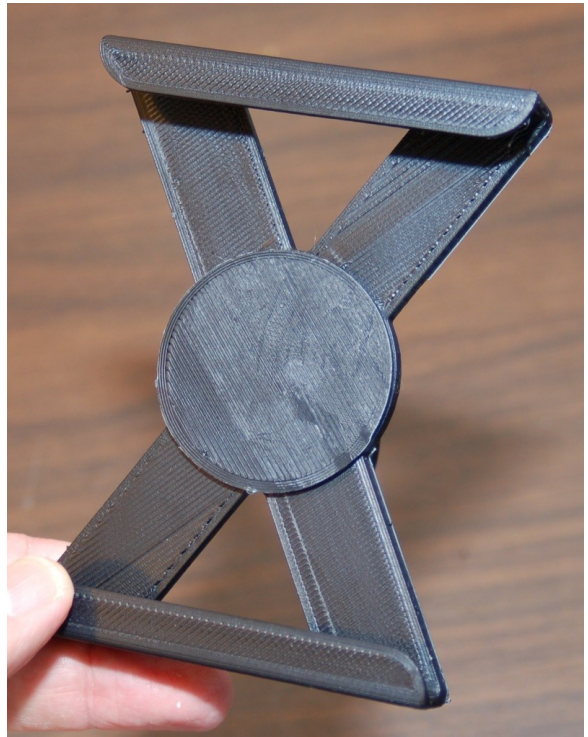

Tablet Bumper in place.



Inserting the tablet into the mount.

Now slide the MatterControl Touch into the tablet mount! Make sure the forward-facing camera is in the upper right corner as shown below.



Installed!

Rostock MAX v2 User's Guide



View from behind.

Now you can install the Base Mount on your Rostock MAX v2. As you can see below, the mount slides right underneath the Onyx Heated Bed.

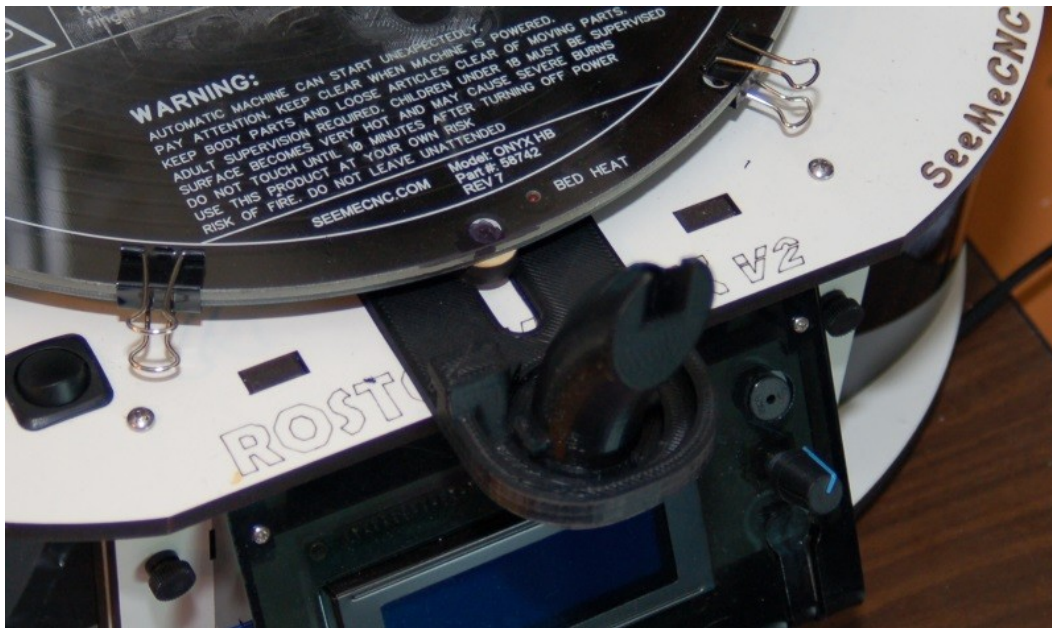

Base Mount installed.

Rostock MAX v2 User's Guide

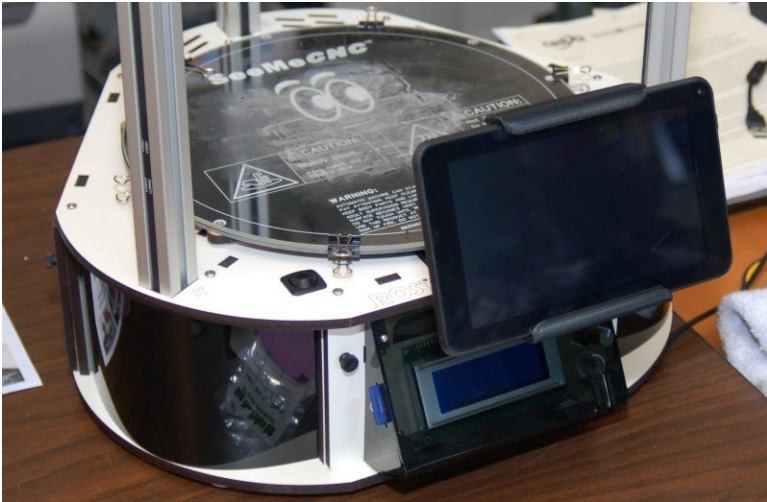

Installation complete!

To finish the installation, insert the Arm Top into the Arm Base as shown on the left.

Now all you need to do is connect your MatterControl Touch to your Rostock MAX v2 using the included Micro USB to USB-A adapter.

Insert the USB cable connected to your Rostock MAX v2, and you're just about ready to go!



Connected!



Micro USB to USB-A Adapter.

Now connect the power adapter included with the MatterControl Touch and you're set!



Ready to Rock n' Roll!

Don't forget to check out the excellent Getting Started guide over at MatterControl's website!

<http://www.matterhackers.com/articles/mattercontrol-touch-getting-started-guide>

Appendix D: Printing From the SD Card

Your Rostock MAX v2 includes the ability to print without being connected to a host computer. In order to do this, you'll need to save sliced files to the supplied SD card. This is really easy to do, but will require that you have an SD card reader. If you don't have one, you can find one on Amazon for as little as \$10.

When you click “Print” in MatterControl, it begins sending GCODE to the Rostock MAX v2 over the USB link. In order to print from SD card, you'll need to save that GCODE to the SD card. In order to do this, click the **Export** button as shown below:

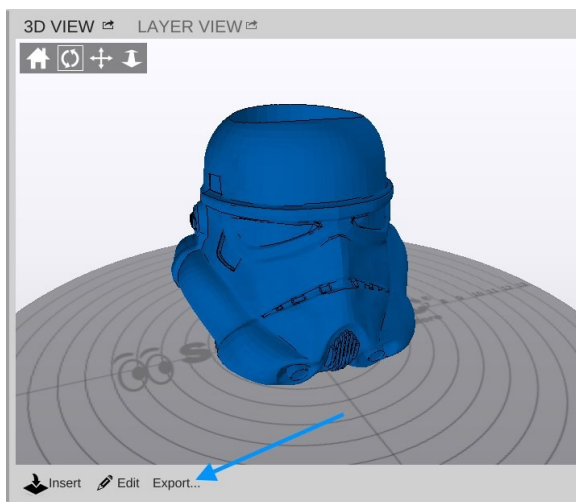

When you click the **Export** button, you'll see the dialog shown below.

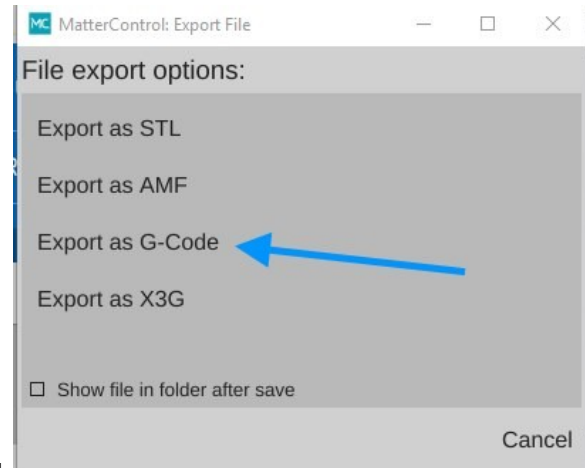

Click on the **Export as G-Code** button and it'll open a standard dialog box to allow you to save the file to your SD card. Once you've saved the file to the SD card, eject it from your computer and insert it into the SD card slot. When you do this, the LCD will display a list of files on the card. An example of this is shown below.

Use the control knob on the LCD to scroll to the filename you just saved to the SD card and press the knob in. This will begin the printing process!

As the print job progresses, the LCD display will show the print progress as a percentage.

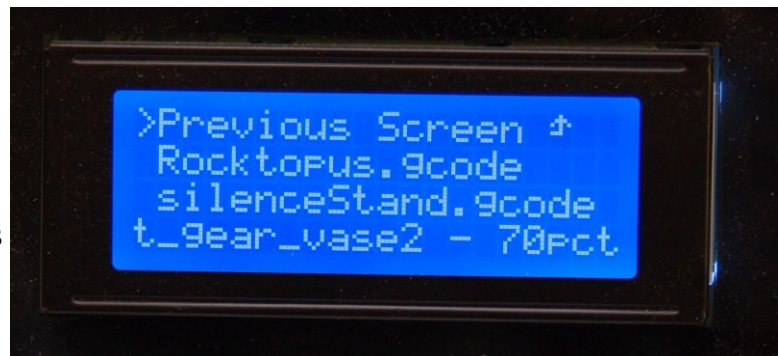

Appendix E: Optimizing The Temperature Control Algorithms

It's important that the temperature controlling algorithm in the RAMBo (the PID loop) be as accurate as possible. To do this, we need to run what is called the “PID Auto tune” routine. This is a firmware function that you run in order to determine the best values for the P(roportional), I(ntegral) and D(erivative) values used by the PID loop. Note that the only time you need to worry about the PID loop is when you change hot ends. The default values included in the firmware have been tuned to work best with the stock hot end. However, if you're replacing the stock hot end with something like a genuine hotends.com J-Head or an E3D Volcano, you'll need to tweak the PID loop as they perform differently than the stock hot end.

First, let's start the auto tune routine for the hot end. Open the terminal window as you have before and send the command “**M303 S200**”. This begins the auto tune process and when it starts, it begins to display information in the terminal window. The target temperature for this process is 200C (that's what the “**S200**” is for).

It will begin with the entry, “PID Autotune start”. You'll notice that the temperature in the hot end will begin to climb. A few minutes later, you'll start to see more information appear in the log window.

The PID auto tune function is “learning” how to better manage the temperature in the hot end.

In a few minutes, the routine will complete, and you'll get output similar to what you see on the right. Enlarge the terminal window so you can see the whole process, from the “Start” label to the “Finished” label.

```
->M303 S200
<-Info:PID Autotune start
<- bias: 65 d: 65 min: 197.73 max: 206.30
<- bias: 64 d: 64 min: 197.42 max: 202.78
<- bias: 61 d: 61 min: 198.03 max: 202.22
<- Ku: 18.53 Tu: 40.27
<- Classic PID
<- Kp: 11.12
<- Ki: 0.55
<- Kd: 55.96
<- bias: 60 d: 60 min: 198.18 max: 202.04
<- Ku: 19.82 Tu: 39.60
<- Classic PID
<- Kp: 11.89
<- Ki: 0.60
<- Kd: 58.85
<- bias: 60 d: 60 min: 198.18 max: 201.85
<- Ku: 20.82 Tu: 39.75
<- Classic PID
<- Kp: 12.49
<- Ki: 0.63
<- Kd: 62.05
<-Info:PID Autotune finished ! Place the Kp, Ki and Kd constants in the Configuration.h or EEPROM
```

Fig. E-1: PID Autotune results.

With some printer builds, the PID auto tune may abort with a message like this: “**Error:PID Autotune failed! Temperature too high**”. This doesn't mean that something is broken, it simply indicates that the RAMBo is applying too much power to the hot end during the auto tune process. This results in an “overshoot” condition where the temperature goes 10+ degrees past the max set point for the auto tune process. In order to fix this, you'll need to *temporarily* dial back the amount of power being used on the hot end. You'll need to edit the setting, “Extr.1 PID drive max” parameter in the EEPROM table.

The EEPROM table editor is on the same screen as the serial terminal. Click on the “**CONFIGURE**” button next to EEPROM Settings to open the editor. Scroll down to the parameter shown below:



Fig. E-2: PID Drive maximum.

By default, this value is 205. Once you've gotten a successful auto-tune, you'll want to restore that value. Change the value to 128 and then click on the “**Save to EEPROM**” button and then restart the auto tune process once the hot end has cooled to room temperature.

Once the auto tune is completed, the values that you're interested in are the “Kp”, “Ki” and “Kd” values. There are three blocks of these values, each under the heading “Classic PID”. Create an average of all the values (add up all the Kp values, divide by three. Do the same with the Ki and Kd values) and we'll get them added to the proper spot in the EEPROM table.

In order to store your new set of PID values, we need to open up the EEPROM table editor. The EEPROM table editor is on the same screen as the terminal. Click on the **CONFIGURE** button next to “EEPROM Settings” to open the editor.

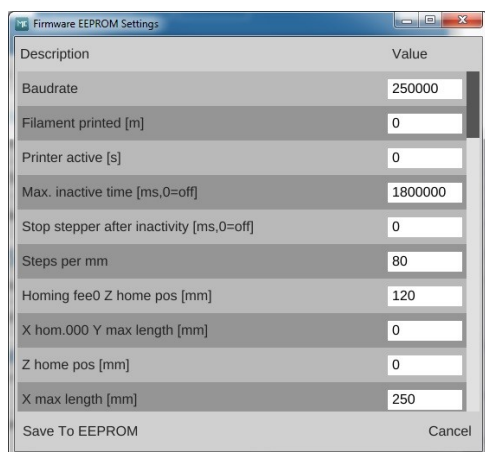

Fig. E-3: EEPROM Table Editor.

Scroll down until you see the fields highlighted in green as shown below. Change the P-gain field to the value you calculated for the average of Kp. Do the same for the I-Gain (Ki) and D-Gain (Kd) values and then click the **Save To EEPROM** button. That's all there is to it!



Fig. E-4: Extruder PID settings.